

RICOH

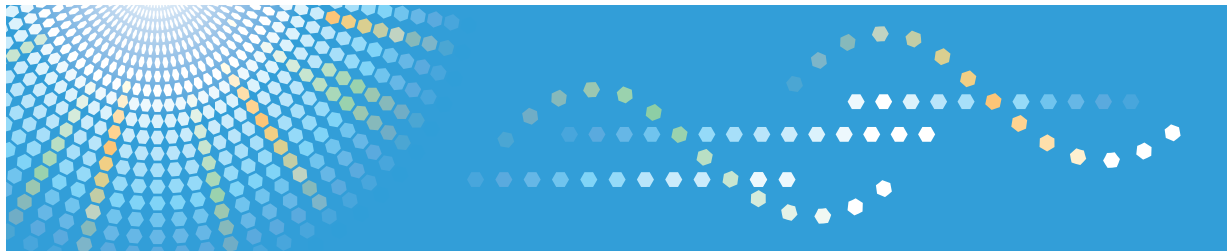

PJ WX4130

Operating Instructions

TABLE OF CONTENTS

Introduction.....	4
Copyrights to Images.....	4
Important.....	4
Notes to Users Viewing 3D Images.....	4
Manuals Provided with the Projector.....	6
Manuals for the Projector.....	6
Manuals List.....	6
Viewing the PDF Manual on the CD-ROM.....	7
How to Read This Manual.....	8
Symbols.....	8
Notes.....	8

1. Preparations for Using the Projector

Main Functions.....	9
Checking the Accessories.....	10
Projector Parts and Their Functions.....	12
Control Panel (Top View).....	12
Front and Left-Side View.....	13
Rear and Right-Side View.....	14
Remote Control Parts and Their Functions.....	15
How to Use the Remote Control.....	17
Effective Range of the Remote Control.....	17
Loading Batteries into the Remote Control.....	18
Operating Multiple Projectors with the Remote Control.....	19
Positioning the Projector.....	21
Relationship Between the Projection Distance and the Screen Size.....	21
Connecting Equipment to the Projector.....	23
Connecting a Computer.....	23
Connecting AV Equipment.....	24
Connecting the Power Cord.....	25

2. Projecting an Image

Basic Operations.....	27
Turning On the Projector.....	28
Selecting an Input Signal.....	29

Adjusting the Angle of the Projection.....	30
Adjusting the Image.....	31
Adjusting the Volume of the Speaker.....	34
Manipulating Images with the Remote Control.....	34
Turning Off the Projector.....	38
3. Changing the Projector Settings	
Viewing the Menu Screen.....	41
Using the Menu Screen.....	43
Restoring Settings to Their Default Settings.....	47
List of Menu Items.....	49
Image Adjustment Menu.....	53
Display Settings Menu.....	57
Default Settings Menu.....	59
Display Status.....	63
4. Troubleshooting	
Indicator Display List.....	65
Common Problems.....	68
Knowledge Base.....	71
5. Maintenance	
Operating Precautions.....	73
Cleaning the Projector.....	74
Cleaning the Projection Window.....	74
Cleaning the Projector.....	74
Replacing the Lamp.....	75
Consumables.....	78
6. Appendix	
Specifications.....	79
Specifications for the Projector.....	79
List of Compatible Signals.....	81
Computer Input.....	81
Y/Pb/Pr Input.....	83
Video Input.....	84
HDMI Input.....	84

Specifications for Ports.....	88
Computer In Port.....	88
Control Port.....	89
Where to Inquire.....	91
Trademarks.....	92
INDEX	93

Introduction

Copyrights to Images

When projecting images using the projector, be careful not to infringe the copyright of protected materials.

The following are examples that may infringe the copyright of protected materials.

- Broadcasting images or movies for commercial purposes
- Modifying images or movies using functions such as freeze, magnify, or zoom to broadcast images for commercial purposes or public viewing
- Varying the aspect ratio of images or movies using a function that changes the screen size to broadcast images for commercial purposes or public viewing

Important

In no event will the company be liable for direct, indirect, special, incidental, or consequential damages as a result of handling or operating the machine.

The manufacturer shall not be responsible for any damage or expense that might result from the use of parts other than genuine parts from the manufacturer with your office products.

Notes to Users Viewing 3D Images

Pay attention to the following points when viewing images using 3D glasses with the projector:

- How 3D images are viewed may vary according to the individual.
- Do not use 3D glasses for viewing any material other than 3D images.
- Before viewing 3D images, make sure to read the manuals provided with your 3D glasses and 3D compatible content.
- Avoid viewing 3D images for a long period of time. Take a break of 15 minutes or longer after every hour of viewing.
- If you feel sick while viewing 3D images, stop viewing them. If you continue to feel sick, consult a doctor.
- When viewing 3D images in a room where an LED lighting system or fluorescent lights are used, you may feel that the light in the room flickers. If this is the case, dim the lights until you do not notice any flickers, or turn off the lights.
- If you or any member of your family has a history of light-sensitive seizures, consult a doctor before viewing 3D images.

-
- To view 3D images, sit in front of the screen so that your eyes are parallel and level with the screen.
 - Viewing 3D images from a place that is too close to the screen may result in eye strain. The distance between the screen and you should be at least three times the height of the screen.
 - Adult supervision is required for children using 3D glasses.
 - Viewing 3D images is not recommended for children under 6 years old. It may negatively affect development of their vision. Consult a doctor before using 3D glasses.

Manuals Provided with the Projector

Manuals for the Projector

Read this manual carefully before you use the projector.

Refer to the manuals that are relevant to what you want to do with the projector.

★ Important

- The manuals are provided in various formats.
- Adobe® Acrobat® Reader®/Adobe Reader must be installed in order to view the manuals as PDF files.

Safety Information

Provides information about safe usage of the projector.

To avoid injury and prevent damage to the projector, be sure to read Safety Information.

Setup Guide

Provides basic information about how to install the projector. Since the contents of this manual are a summary of Operating Instructions, see Operating Instructions for detailed information.

Operating Instructions

Provides information about how to install the projector, how to project images using the projector, and how to configure the projector. It also provides information about troubleshooting and maintenance.

Manuals List

Manual Name	Printed Manuals Provided	PDF Manuals Provided
Safety Information	Yes	No
Setup Guide	Yes	No
Operating Instructions	No	Yes

Viewing the PDF Manual on the CD-ROM

This section describes how to view the PDF manual on the supplied manual CD-ROM.

File path

The manual is included in the following folder on the CD-ROM:

Manual\<(language)

1. **Insert the CD-ROM in the CD-ROM drive of your computer.**
2. **Double-click the "Manual" folder.**
3. **Double-click the folder corresponding to your language.**
4. **Double-click the PDF file.**

The PDF manual is displayed on the screen.

Note

- To view the PDF manuals, you need to have Adobe Acrobat Reader/Adobe Reader installed on your computer.

How to Read This Manual

Symbols

This manual uses the following symbols:



Indicates points to pay attention to when using the projector.



Indicates supplementary explanations of the projector's functions, and instructions on resolving user errors.



Indicates the names of buttons on the control panel and remote control. It also indicates items displayed on the menu screens.

Notes

Contents of this manual are subject to change without prior notice.

Two kinds of size notation are employed in this manual.

Some illustrations in this manual might be slightly different from the machine.

Certain options might not be available in some countries. For details, please contact your local dealer.

Depending on which country you are in, certain units may be optional. For details, please contact your local dealer.

1. Preparations for Using the Projector

This chapter explains the names and functions of the different parts of the projector and remote control, and how to use them. It also explains how to position the projector and how to connect it to other equipment.

Main Functions

The projector features the following functions that you can use.

Auto set function

The projector detects the signal and adjusts for flickering and the position of the projected image if you press the [Auto set] button when the projector is connected to a computer.

Auto keystone function

The projector automatically adjusts the shape of the projected image according to the angle at which the projector is positioned.

AV Mute/Freeze

Pressing the [AV Mute] button mutes the sound and blanks the screen. Pressing the [Freeze] button pauses the image temporarily.

Magnify/Zoom

Pressing the [Magnify] button enlarges the projected image. Pressing the [Zoom] button reduces the projected image.

Wall color correction

You can adjust the hue of the image in accordance with the color of the wall on which it is projected.

Password setting/Key lock

You can specify a password for the projector to limit the people that can use it. The buttons on the control panel can be disabled with the key lock setting to prevent misoperation.



User logo function

The projector can project a registered logo or image when there is no signal or when it is starting up.

Checking the Accessories

The projector is provided with the following accessories. Make sure that everything is included in the package.

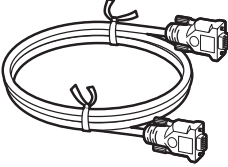
If anything is missing or damaged, contact your sales representative or service representative.

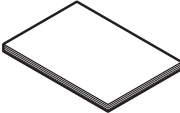
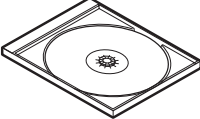
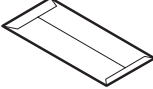
Remote control AAA battery LR03 (2 ea)	
RGB cable (3 m)	
Power cord	
Carrying bag	
Safety Information Setup Guide	
CD-ROM	
Warranty card	

↓ Note

- The bundled accessories may vary depending on the location that this product was purchased.
- Use only the RGB cable provided with the projector.
- Use only the power cord set provided with the projector.

- The Operating Instructions are on the provided CD-ROM. For procedures about how to read Operating Instructions, see p.7 "Viewing the PDF Manual on the CD-ROM".

Projector Parts and Their Functions

1

Control Panel (Top View)

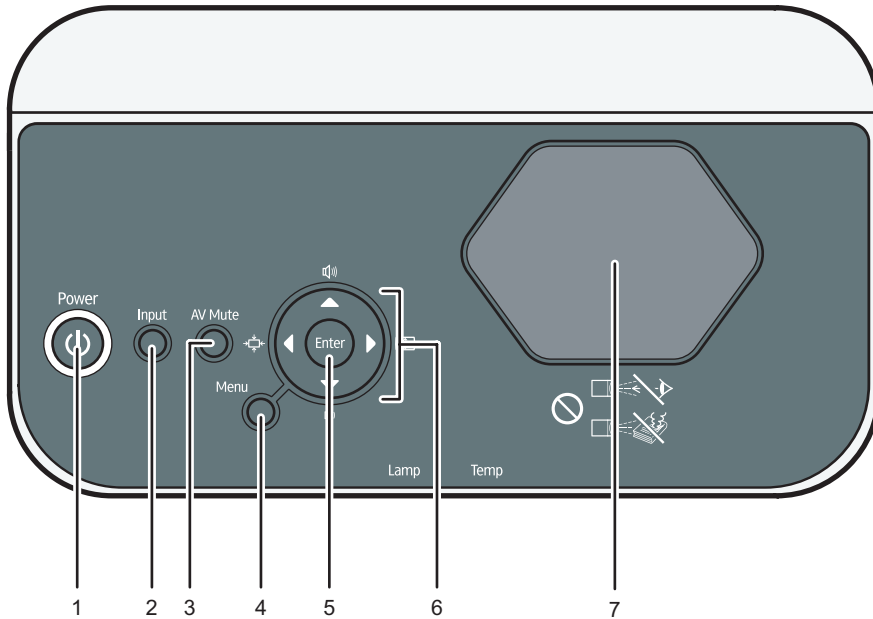

CLB009

1. [Power] button

Turns the projector on and off. You can confirm the status of the projector with the indicator.

- On: Power is on.
- Off: Power is off.
- Flashing at 1 or 3 second intervals: Standby.
- Flashing at short intervals: Starting up or cooling.

2. [Input] button

Switches the signal input. The input signal changes each time the button is pressed.

3. [AV Mute] button

Temporarily blanks the screen and mutes the audio.

4. [Menu] button

Displays the menu screen. Press it again to close the menu screen.

5. [Enter] button

Enters the selected mode.

6. Arrow buttons

Used to operate the menu screen. The [▶] and [◀] buttons are used to adjust the size of the projected image. The [▲] and [▼] buttons are used to adjust the volume.

7. Projection window

Enlarges and projects the image (light).

Note

- The top of the projector is covered with a protective film when it is shipped. Remove the film before using the projector.

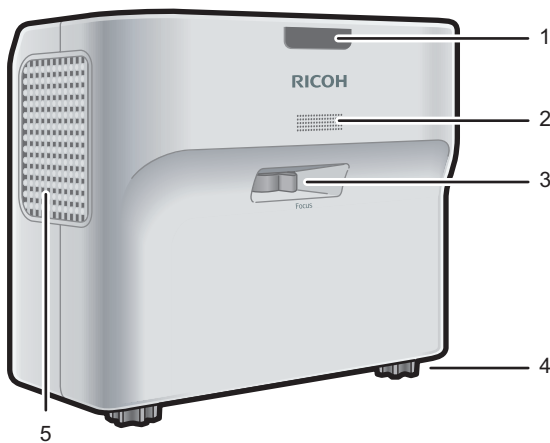
Front and Left-Side View

CLB010

1. Remote control receiver, LED indicators

Receives the signal from the remote control. You can confirm the status of the projector by referring to the LED indicators. The left LED shows the status of the lamp, and the right LED shows the temperature inside the projector. For details, see p.65 "Indicator Display List".

2. Speaker

Outputs the audio input from an external device.

3. Focus lever

Adjusts the focus of the image.

4. Adjustable feet

Adjusts the angle of the projection.

5. Exhaust vents

Releases hot air from inside the projector.

Rear and Right-Side View

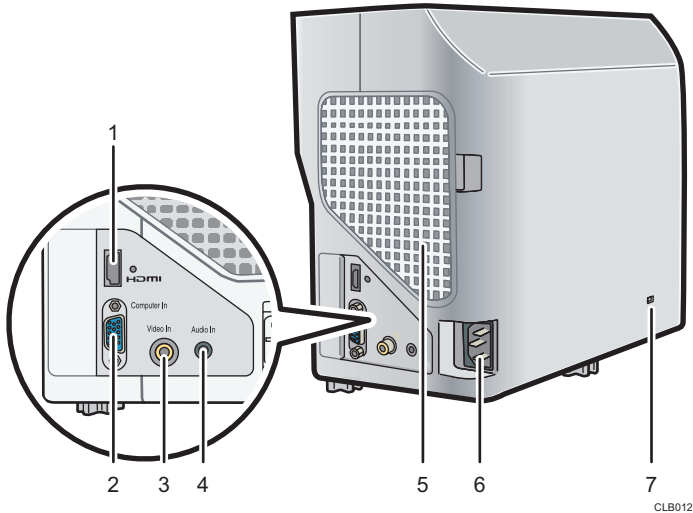

1. HDMI port

For connecting an HDMI (High-Definition Multimedia Interface) cable.

2. Computer In port (Y/Pb/Pr)

For inputting RGB signals from a computer or component image signals (Y/Pb/Pr) from a video player.

3. Video In port

For inputting image signals from a video player.

4. Audio In port

For inputting audio signals from a computer or video player.

5. Intake vents

For circulating air from the outside to cool the projector.

6. AC In socket

For connecting the power cord set provided with the projector.

7. Security slot

For connecting an anti-theft cable.

Remote Control Parts and Their Functions

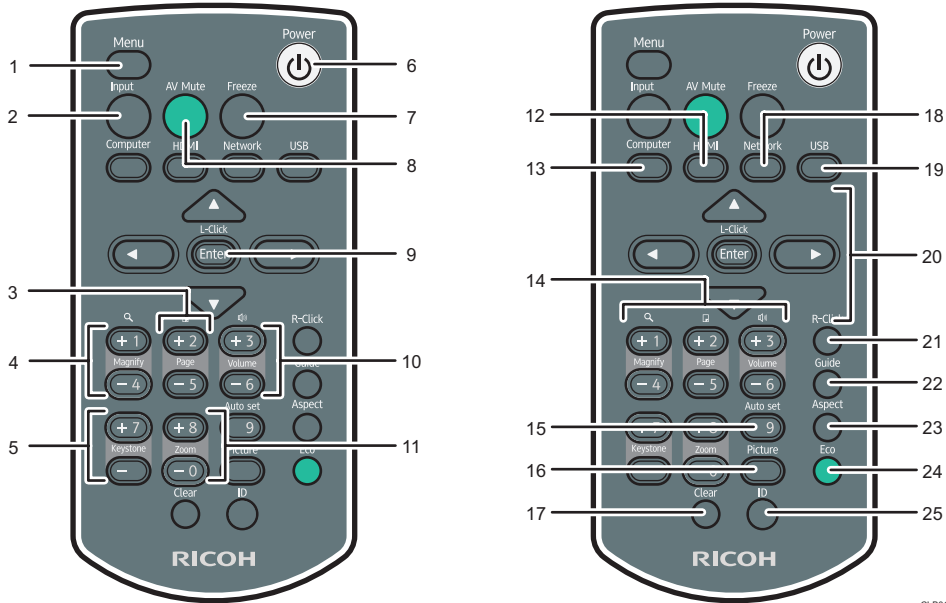

CLB013

1. [Menu] button

Displays the menu screen. Press it again to close the menu screen.

2. [Input] button

Switches the signal input. The signal that is input changes each time the button is pressed.

3. [Page] buttons

This button is not used.

4. [Magnify] buttons

Enlarges the image. Press the $[+]$ button to enlarge the image. Press the $[-]$ button to reduce the image to its original size.

5. [Keystone] buttons

Adjusts for keystone distortion. Press the $[+]$ button to increase the correction value. Press the $[-]$ button to decrease the correction value.

6. [Power] button

Turns the projector on and off.

7. [Freeze] button

Temporarily pauses the image.

8. [AV Mute] button

Temporarily blanks the screen and mutes the audio.

9. [Enter] button

Enters the selected item or mode.

10. [Volume] buttons

Adjusts the volume of the speaker. Press the [+] button to increase the volume. Press the [-] button to decrease the volume.

11. [Zoom] buttons

Reduces the image. Press the [-] button to reduce the image. Press the [+] button to enlarge the image to its original size.

12. [HDMI] button

Switches to HDMI input mode.

13. [Computer] button

Switches to computer input mode. If only the Y/Pb/Pr signal is input, the Y/Pb/Pr screen appears when you press this button.

14. Number buttons

Used to enter numbers.

15. [Auto set] button

Automatically adjusts the image to match the signal input from a computer.

16. [Picture] button

Switches the screen mode.

17. [Clear] button

Deletes entered characters.

18. [Network] button

This button is not used.

19. [USB] button

This button is not used.

20. Arrow buttons

Used to operate the menu screen.

21. [R-Click] button

This button is not used.

22. [Guide] button

This button is not used.

23. [Aspect] button

Switches the size of the projected image.

24. [Eco] button

Switches the lamp power level.

25. [ID] button

Registers the remote control ID.

How to Use the Remote Control

You can use the remote control to turn the projector on and off, and to change the signal of the image being input and projected. You can also enlarge or reduce the image and mute the audio.

Note the following precautions when using the remote control:

- Do not drop or hit the remote control.
- Do not place the remote control in a place that is very hot or very humid.
- Do not get the remote control wet. Also, do not place it on anything that is wet.
- Do not dismantle the remote control.

Effective Range of the Remote Control

Point the remote control at the remote control receiver on the projector to use it.

The effective range of the remote control is about 4.5 meters (14.7 feet) from the receiver and at an angle of about 15 degrees to the remote control receiver on the projector.

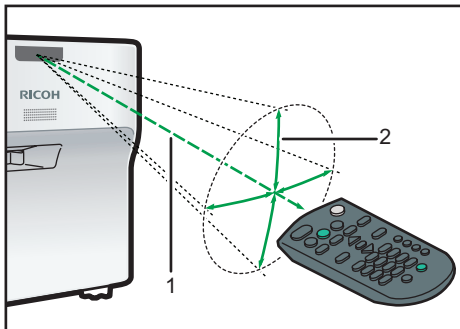

1. **Distance: up to 4.5 meters (14.7 feet)**
2. **Angle: within 15 degrees**

↓ Note

- The remote control may not be effective in some areas and in some conditions. If this happens, point the remote control at the projector and try it again.
- The remote control may not work if the remote control receiver on the projector is exposed to sunlight, fluorescent light, or strong light.

Loading Batteries into the Remote Control

WARNING

- For safe operation, follow the warnings below regarding the batteries used in the remote control. If you use the batteries incorrectly, it may result in fire or injury due to batteries leaking or exploding.
 - Do not use batteries other than the ones specified.
 - Do not mix and use batteries that are different types or that are new and old.
 - Correctly insert batteries according to the polarity (+/-).
 - Do not charge non-rechargeable batteries.
 - Do not heat or throw the batteries into fire or water.
 - Do not connect the positive and negative terminals on a battery with a wire.
 - Remove the batteries from the remote control that are past their suggested use period or that are depleted.
 - Remove the batteries when they will not be used for extended periods.
 - Keep the batteries out of the reach of children. Children may swallow or choke on the batteries. If this happens, contact a doctor immediately.

1. Remove the battery cover from the remote control.

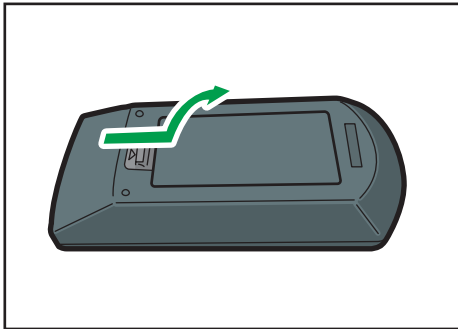

CLB015

2. Insert the batteries.

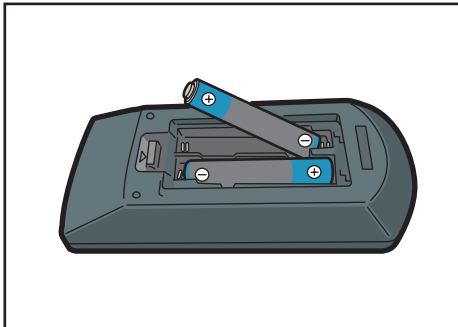

CLB016

Note the direction of the positive and negative terminals when inserting the batteries.

3. Close the battery cover.

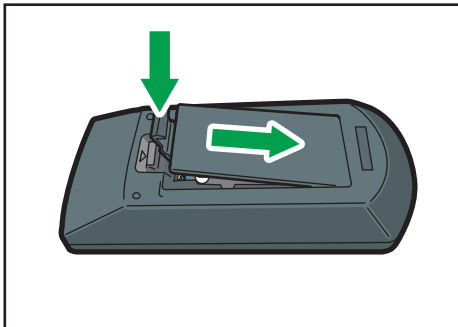

CLB017

↓ Note

- Replace the batteries if the remote control does not work or if the effective distance becomes too narrow.

Operating Multiple Projectors with the Remote Control

You can operate multiple projectors with a single remote control. It is possible to operate a maximum of four projectors.

You need to specify an ID number to assign to each projector in [Remote Control ID] under [Default Settings] in advance.

1. While pressing the [ID] button, press the number button that corresponds to the ID number of the projector to be operated for three seconds or more.

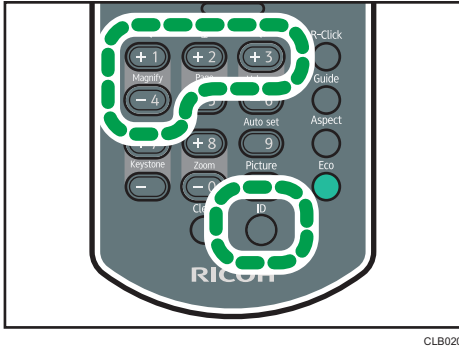

The ID number assigned to the remote control is changed.

2. Operate the projector.

Note

- The remote control cannot operate a projector unless the ID on the remote control is the same as the controller ID specified in the projector's Default Settings menu.
- The ID number specified in the remote control is effective until a different ID number is specified.
- The ID number in the remote control must be specified again if the batteries are changed.

Positioning the Projector

When positioning the projector, place it so that the projector's rear side faces the screen. Make sure the projector and the screen are parallel to each other.

Adjust the distance between the projector and the screen according to the size of the projected image. For details, see p.21 "Relationship Between the Projection Distance and the Screen Size".

Projection Mode

You can position the projector in one of two ways.

Select the setting according to the position of the projector in [Projection Mode] under [Default Settings]. For details, see p.59 "Default Settings Menu".

- Standard

The projector is placed in front of a screen onto which the images are projected.

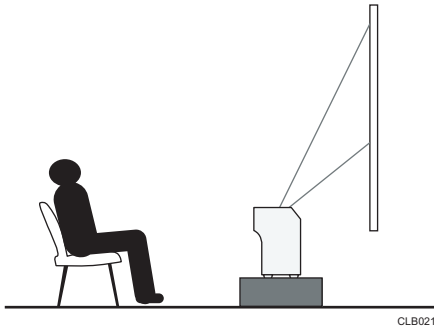

- Rear

The projector is placed behind a screen onto which the images are projected.

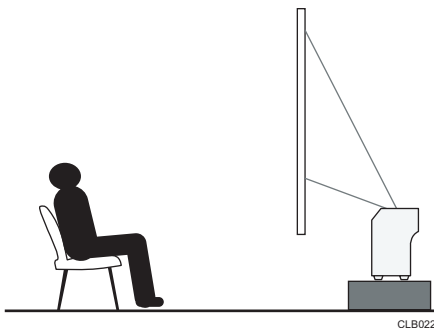

Relationship Between the Projection Distance and the Screen Size

The size of the projected image varies according to the distance from the projector to the screen.

Refer to the following table to position the projector in a suitable position.

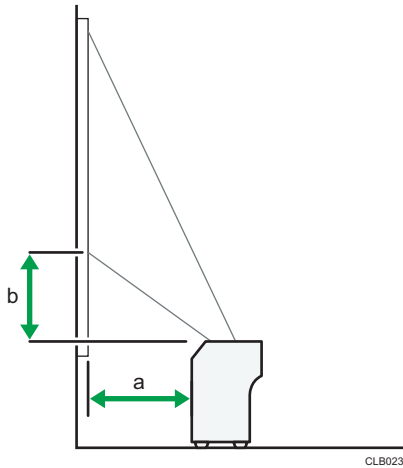

CLB023

Projection size ^{*1}	a Projection distance	b Projection height
48 inches	12 cm (4.6 inches)	9 cm (3.7 inches)
60 inches	17 cm (6.5 inches)	12 cm (4.7 inches)
80 inches	25 cm (9.8 inches)	16 cm (6.2 inches)

*1 The sizes of the projected images are for a full size image without keystone adjustment.

Connecting Equipment to the Projector

⚠ CAUTION

- Do not place the power cord and connection cable in a way that might cause someone to trip and fall. The product might fall over and cause an injury.

Various equipments can be connected to the projector.

Turn off the power to any equipment before connecting it to the projector. Be sure to read the manual for the applicable equipment before connecting it to the projector.

Connecting a Computer

Connect an RGB cable to the Computer In port of the projector and to the RGB output of a computer. To input audio signals, connect an audio cable to the Audio In port of the projector and to the audio output of a computer.

If an HDMI interface is available on a computer you want to use, connect an HDMI cable to the HDMI ports of the projector and the computer.

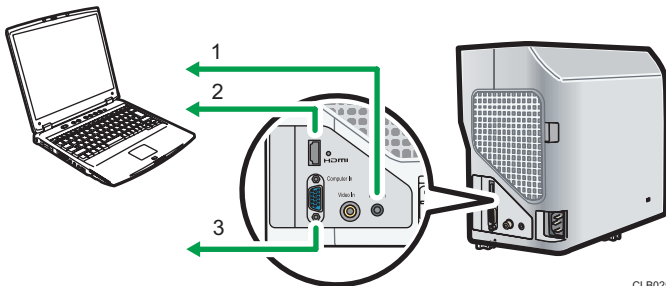

CLB025

1. To the audio output
2. To the HDMI port
3. To the RGB output

↓ Note

- Some computers cannot be connected to the projector. Before connecting a computer to the projector, check the output terminals and signal compatibility.
- To input a DVI signal to the projector, connect a conversion adapter or cable to the Computer In port or the HDMI port of the projector.
- The Audio In port is used for equipment that connects to the Computer In port or Video In port.

Connecting AV Equipment

Use a cable that supports the signal being input when connecting AV equipment.

To connect a DVD recorder, connect a conversion adapter BNC-pin to the Computer In port of the projector and to the Y/Pb/Pr output of the recorder.

To connect a video recorder or a DVD player, connect a video cable to the Video In port of the projector and to the video output of the recorder or the player.

To input audio signals, connect an audio cable to the Audio In port of the projector and to the audio output of the recorder or the player.

If an HDMI interface is available on a device you want to use, connect an HDMI cable to the HDMI ports of the projector and the device.

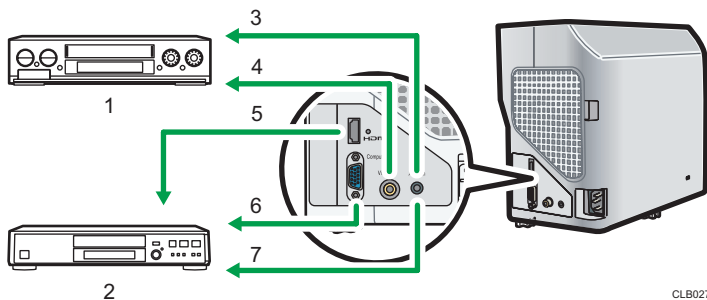

1. Video player, DVD player
2. DVD recorder
3. To the audio output
4. To the video output
5. To the HDMI port
6. To the Y/Pb/Pr output
7. To the audio output

Note

- The Audio In port is used for equipment that connects to the Computer In port or Video In port.
- Some devices may not operate properly when connected using HDMI.
- Use only an HDMI cable that has the HDMI logo. To input 1080p image signals, use a high-speed HDMI cable. A conventional HDMI cable may not work properly.

Connecting the Power Cord

WARNING

- Do not use any power sources other than those that match the specifications shown. Doing so could result in fire or electric shock.

WARNING

- Do not use any frequencies other than those that match the specifications shown. Doing so could result in fire or electric shock.

WARNING

- The supplied power cord is for use with this machine only. Do not use it with other appliances. Doing so could result in fire or electric shock.

WARNING

- It is dangerous to handle the power cord plug with wet hands. Doing so could result in electric shock.

CAUTION

- Do not place the power cord and connection cable in a way that might cause someone to trip and fall. The product might fall over and cause an injury.

CAUTION

- Push the power plug all the way into the power outlet. Do not use a power outlet with a loose connection. Doing so may result in heat buildup. Plug the power cord in the correct direction into the base. If they are not plugged in correctly, it could result in smoke, fire, or electric shock.

CAUTION

- When disconnecting the power cord from the wall outlet, always pull the plug, not the cord. Pulling the cord can damage the power cord. Use of damaged power cords could result in fire or electric shock.

1. Insert the connector of the power cord set into the AC In socket on the right side of the projector.

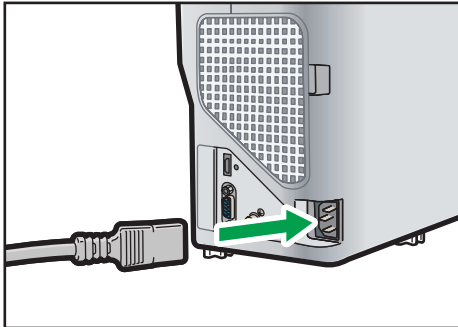

CLB029

2. Insert the power plug into a power outlet.

Note

- Do not place anything near the power outlet.
- When [Power On Method] in [Default Settings] is specified as [Auto.], the projector turns on as soon as the power plug is inserted in a power outlet (direct power on).

2. Projecting an Image

This chapter explains the procedure for projecting an image.

Basic Operations

WARNING

- Do not look into the projection window or vent when the product is on. The bright light may damage your eyes. Be especially careful in an environment with children.

CAUTION

- Do not place low heat resistant material near the exhaust vents. Hot air may come from the exhaust vents, resulting in damage to the product or an accident.

CAUTION

- Do not block the projection light when it is on. If you do so, the part that is blocking the projection light may get quite hot and deform, deteriorate or cause a burn or fire. The reflected light may make the projection window hot and cause a product failure. To temporarily suspend projection, select the mute function. To suspend longer, turn off the product.

Important

- **Unplug the power cord if the projector will not be used for an extended period of time.**
- **If the lamp is used for an extended period of time, it may not light up or the image may become dark. If this happens, replace the lamp. In some rare cases, the lamp's brightness may vary slightly due to the characteristics of a lamp.**

Note

- The projector supports various RGB signals, but signals that are not WXGA signals are expanded or compressed when displayed and the image quality is slightly decreased. We recommend setting the computer's output to WXGA to get better image quality.
- The motion of images in videos projected using the DVD software on a computer may seem unnatural.
- Connect the projector and equipment before using the projector. For details, see p.23 "Connecting Equipment to the Projector".
- If [Key Lock] in [Default Settings] is specified as [On], you cannot operate the projector from its control panel. Use the remote control.
- If you press a button that is disabled, the projector beeps and an error icon appears on the screen.
- If [Beep] in [Default Settings] is specified as [Off], the projector does not beep.

Turning On the Projector

Make sure that the power plug is inserted into a power outlet. For details, see p.25 "Connecting the Power Cord".

1. Press the [Power] button.

2

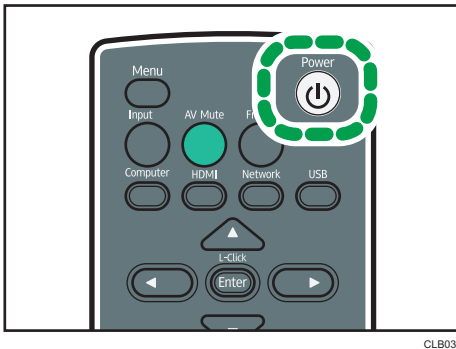

The projector beeps and the indicator flashes blue.

The start-up screen is displayed.

Note

- Make sure the projector is positioned squarely in front of the screen. For details, see p.21 "Positioning the Projector".
- When the projector is turned on for the first time after it is purchased, the start menu appears. Specify the display language and lamp power level. For details, see p.28 "When the start menu is displayed".
- The password input screen is displayed if a password for the projector is specified in [Password] under [Default Settings]. Enter a password.
- When [Power On Method] in [Default Settings] is specified as [Auto.], the projector turns on as soon as the power plug is inserted in a power outlet (direct power on).
- The start-up screen closes shortly after appearing. You can specify that the start-up screen not appear in [Start-up Screen] under [Display Settings].

When the start menu is displayed

When the projector is turned on for the first time after it is purchased, specify the display language and lamp power level.

1. Select the display language, and then press the [Enter] button.
2. Select the lamp power level, and then press the [Enter] button.

↓ Note

- The start menu is only displayed the first time the projector is used. However, the start menu is displayed when the projector is turned on after [Reset All] in [Default Settings] is executed.
- The display language and lamp power level can also be changed in the menu screen. For details, see p.59 "Default Settings Menu".

Selecting an Input Signal

Select a signal that is compatible with the equipment that is connected to the projector.

1. Turn on the equipment that is connected to the projector.

To project the image of a video player, press the play button on the video player.

2. Press the [Input] button.

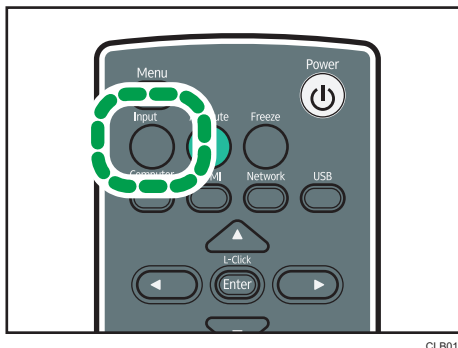

CLB019



The input signal is detected automatically and the image is projected. The input signal changes each time the [Input] button is pressed.

↓ Note

- In step 2, the input signal selection screen appears if [Off] is specified for [Auto Input Search] in [Default Settings]. Select a signal that is compatible with the equipment that is connected.
- Switch the computer's image output when projecting a notebook computer's screen. For details, see p.30 "When projecting the screen of a notebook computer".
- You can also select the input signal directly with the [Computer] or [HDMI] button on the remote control.
- The image specified in [Background on NoSignal] under [Display Settings] is displayed if the signal is lost or there is no signal being input from the connected equipment. Check that the equipment is turned on and that it is properly connected to the projector.
- If the project does not support the input signal, a "Unsupported signal" message is displayed.

When projecting the screen of a notebook computer

When connecting a notebook computer to the projector, switch the computer's image output.

In Windows operating systems, the image output can be switched with a function key. While pressing and holding the [Fn] key, press the  key, the  key, or the LCD/VGA function key.

Examples of various computers

Computer brand	Key combination
MSI	[Fn] + [F2]
Everex, Mitsubishi, NEC, Panasonic, Sotec	[Fn] + [F3]
Gateway, HP	[Fn] + [F4]
acer, Sharp, Sotec, Toshiba	[Fn] + [F5]
Hitachi, IBM, lenovo, Sony	[Fn] + [F7]
Asus, Dell, Epson, Hitachi	[Fn] + [F8]
Fujitsu	[Fn] + [F10]

Note

- Depending on the computer, the image may not be projected properly if it is displayed on the computer's LCD display while being projected onto the screen by the projector. If this happens, turn off the computer's LCD display. For details about switching the display, see the manual provided with the computer.
- For details about operating the computer, see the manual provided with the computer.

Adjusting the Angle of the Projection

You can adjust the height of the projected image by using the adjustable feet to change the angle of the projector.

1. Lift the front of the projector and adjust the length of the adjustable feet.

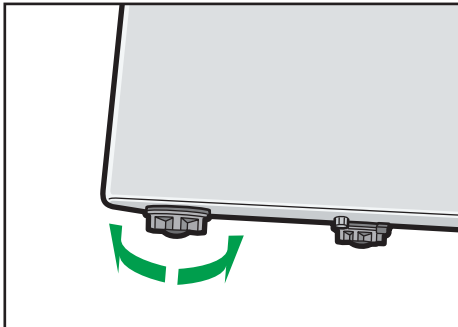

CLB031

Turn the adjustable feet to the left to make it longer. Turn the adjustable feet to the right to make it shorter.

↓ Note

- Adjust the height of the right and left adjustable feet so the projector is level. If the projector is inclined too much, an error occurs and operation cannot be performed.
- The projector automatically adjusts the projected image for keystone distortion according to the projection angle. If [Auto Keystone] in [Default Settings] is specified as [Off], manually adjust for keystone distortion. For details, see p.33 "Adjusting for keystone distortion".

Adjusting the Image

Adjust the focus of the projected image with the focus lever. If there is any keystone distortion, adjust it with the [Keystone] buttons on the remote control.

If the projected image is larger than the screen, adjust the size of the image using the [Zoom] buttons.

Changing the size of the projected image

Reduces and displays the image. The image can be reduced in a range of 80 to 100%.

If the projected image is larger than the screen, reduce the size of the image using the [Zoom] buttons.

1. Press the [Zoom⁻] button to reduce the image.

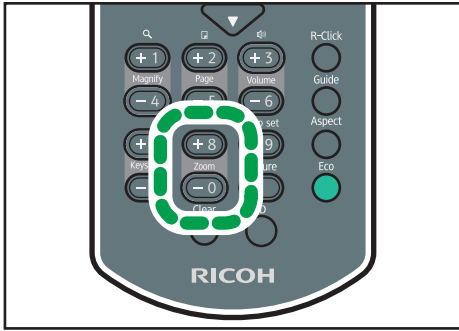

CLB037

The ratio decreases each time the [-] button is pressed. You can confirm the current ratio on the value bar at the bottom of the screen.

2. Press the [Zoom⁺] button to enlarge the image.

The ratio increases each time the [+] button is pressed. The image is enlarged until it reaches the original size.

Note

- You can also adjust the size of the projected image from the control panel on the projector.
- The image may sometimes be disrupted while it is reduced.

Adjusting the focus

Adjust the focus of the projected image.

1. Move the focus lever on the front of the projector to the left or right.

The shape of the projected image changes slightly when the focus lever is moved.

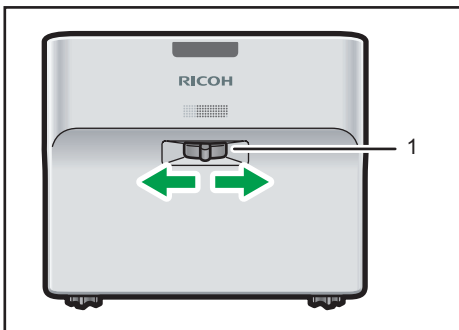

CLB032

1. Focus lever

Adjusting for keystone distortion

If the projector is placed at an angle, the projected image will be distorted. This is called keystone distortion.

If [Auto Keystone] in [Default Settings] is specified as [Off], manually adjust for keystone distortion.

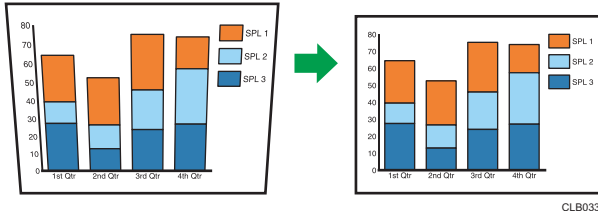

CLB033

1. Press the [Keystone⁺] and [Keystone⁻] buttons to adjust the keystone distortion.

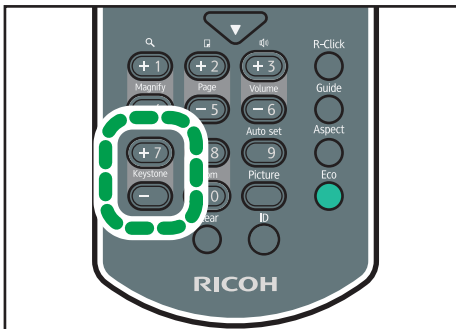

CLB063

The value bar appears at the bottom of the screen. Press the [+] button to increase the correction value. Press the [-] button to decrease the correction value.

↓ Note

- Some data may be lost or the image quality may be degraded depending on the degree of the keystone adjustment and the type of the image.
- You can manually adjust for keystone distortion even if [Auto Keystone] is specified as [On]. However, if you change the angle of the projector, it is automatically adjusted again.
- The keystone adjustment level stays registered even if the projector is turned off. We recommend that you specify [Auto Keystone] to [Off] if the projector and screen are permanently installed.

Automatically adjusting the image

The image quality and position are automatically adjusted according to the input signal.

This function is available when you select [Computer] as an input signal.

1. Press the [Auto set] button.

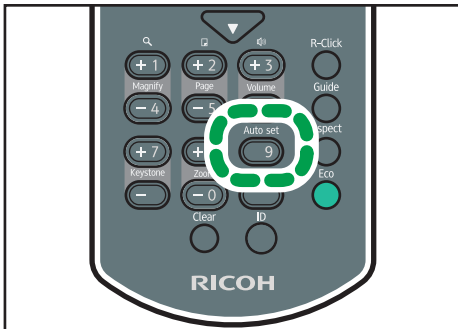

CLB034

Note

- Depending on the type of input signal, some images may not be displayed or correctly adjusted. If this happens, adjust the image with [Position] in [Image Adjustment]. For details about the types of signals that can be input to the projector, see p.81 "List of Compatible Signals".

Adjusting the Volume of the Speaker

1. Press the [Volume+] and [Volume-] buttons to adjust the volume.

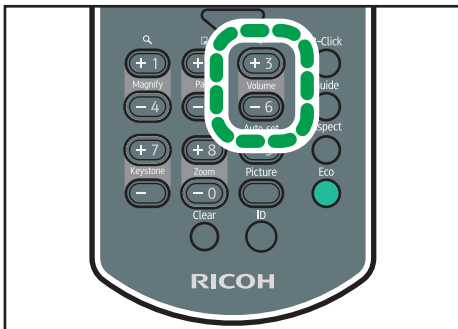

CLB035

The value bar appears at the bottom of the screen. Press the [+] button to increase the volume. Press the [-] button to decrease the volume.

Note

- You can also adjust the volume of the speaker from the control panel on the projector.

Manipulating Images with the Remote Control

Use the remote control to manipulate projected images.

Enlarging the image

Enlarges and displays a part of the image. The image can be enlarged in a range of 100 to 200%. The enlarged image becomes grainy due to the digital processing.

1. Press the [Magnify⁺] button to enlarge the image.



CLB036

The ratio increases each time the [+] button is pressed.

Pressing the [▲], [▼], [◀], and [▶] buttons moves the display position of the enlarged image.

2. Press the [Magnify⁻] button to reduce the image.

The ratio decreases each time the [-] button is pressed. The image is reduced until it reaches the original size.

↓ Note

- An icon appears on the screen when the image is enlarged.
- The Magnify function is canceled automatically if any operation is performed.
- The image may sometimes be disrupted while it is enlarged or while moving the enlarged portion.

Temporarily blanking the image and muting the audio

Temporarily blanks the screen and mutes the audio.

This is useful when projecting images from another projector or an OHP.

1. Press the [AV Mute] button.

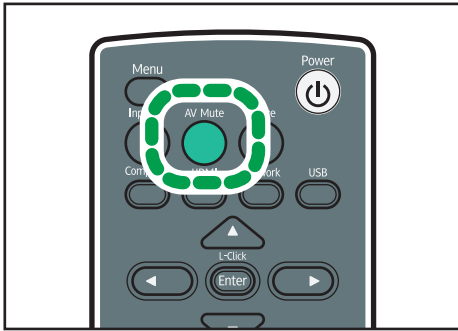

CLB038

The image blanks and the audio mutes.

2. To cancel this function, press the [AV Mute] button again.

Note

- An icon appears on the screen when mute is used.
- The mute function is canceled automatically if any button on the control panel is pressed.
- You can also use the [AV Mute] button on the projector's control panel.

Pausing the image

Pauses the video or moving image that is being projected.

1. Press the [Freeze] button.

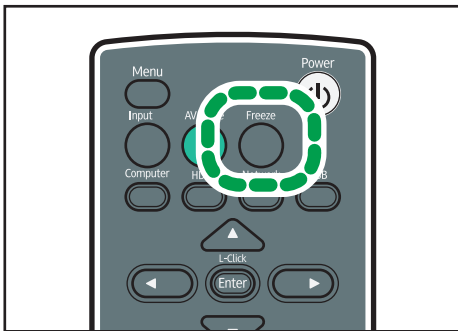

CLB041

The image is paused.

2. To cancel this function, press the [Freeze] button again.

Note

- An icon appears on the screen when freeze is used.
- The Freeze function is canceled automatically if any operation is performed.

- When the [Freeze] button is pressed, the image that is being projected at that time is stored in memory, and that image is projected. Because of this, even though the projector has paused the image, the equipment continues to play the video.

Changing the image quality

1. Press the [Picture] button.

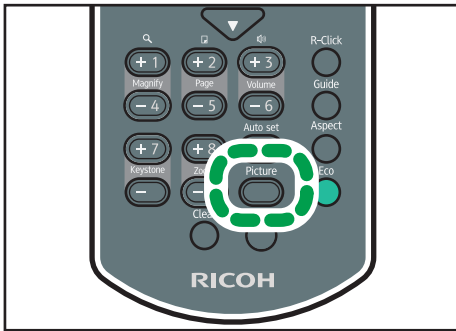

CLB039

2. Select a setting from the list using the [▲] and [▼] buttons, and then press the [Enter] button.

Note

- You can also change the screen mode with [Image Adjustment]. For items that can be specified, see p.53 "Image Adjustment Menu".

Changing the aspect ratio of the projected image

1. Press the [Aspect] button.



CLB040

2. Select a setting from the list using the [▲] and [▼] buttons, and then press the [Enter] button.

Note

- You can also change the aspect with [Display Settings]. For items that can be specified, see p.57 "Display Settings Menu".

Switching the lamp mode

2

Select eco mode if the image is too bright or when projecting images in a dark room.

1. Press the [Eco] button.

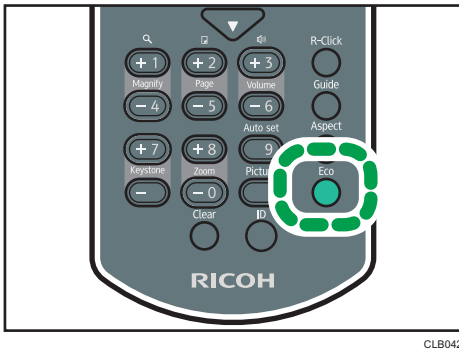

CLB042

The mode changes each time the button is pressed.

Note

- You can also change the lamp power level with [Default Settings]. For items that can be specified, see p.57 "Display Settings Menu".

Turning Off the Projector

1. Press the [Power] button.

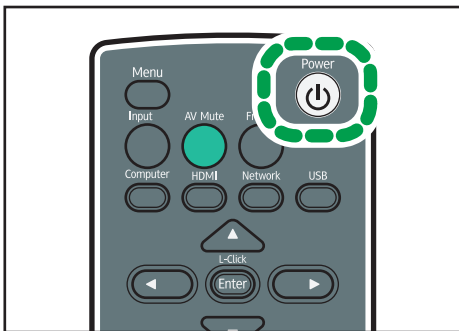

CLB030

The confirm screen appears.

2. Press the [Power] button.

The projector beeps and the projector turns off.

↓ Note

- After turning the projector off, wait about five minutes for the lamp to cool before turning the projector on again. The lamp may not light if it is very hot.
- The projector turns off as soon as the power plug is removed from the power outlet (direct power off).

3. Changing the Projector Settings

This chapter explains the settings on the menu screen and how to change the settings.

Viewing the Menu Screen

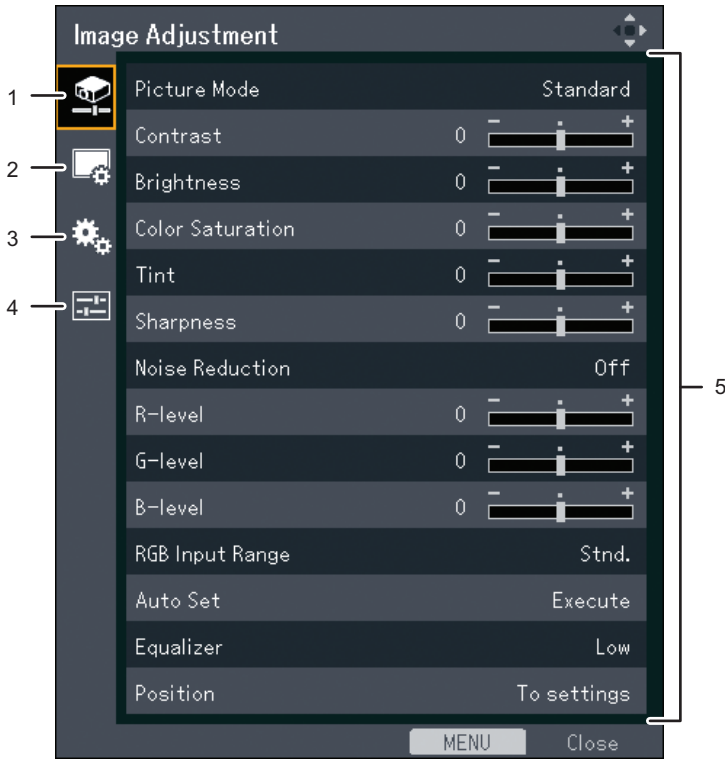

CLB047

1. Image Adjustment menu tab

Enables the image items to be adjusted and configured.

For the Image Adjustment menu settings, see p.53 "Image Adjustment Menu".

2. Display Settings menu tab

Enables the screen display items to be configured.

For the Display Settings menu settings, see p.57 "Display Settings Menu".

3. Default Settings menu tab

Enables the installation status, etc., to be configured.

For the Default Settings menu settings, see p.59 "Default Settings Menu".

4. Display Status tab

Enables information such as input signals and lamp usage time, etc., to be displayed.

For item that can be displayed, see p.63 "Display Status".

5. Settings

The settings and information for each menu can be displayed.

For the list of possible settings for each menu, see p.49 "List of Menu Items".

Using the Menu Screen

This section explains the methods for changing the menu screen using the remote control.

1. Press the [Menu] button.

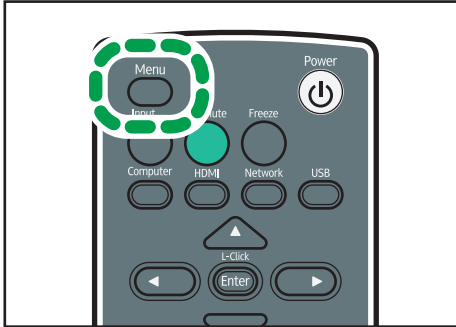

CLB046

3

2. Select the menu tab using the [▲] and [▼] buttons.

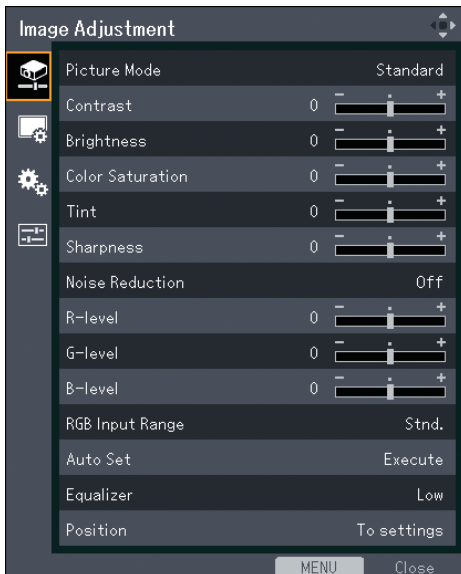

If you select the Display Status tab, you can confirm the information in this step.

3. Press the [▶] button.

4. Select the item to be changed using the [▲] and [▼] buttons.

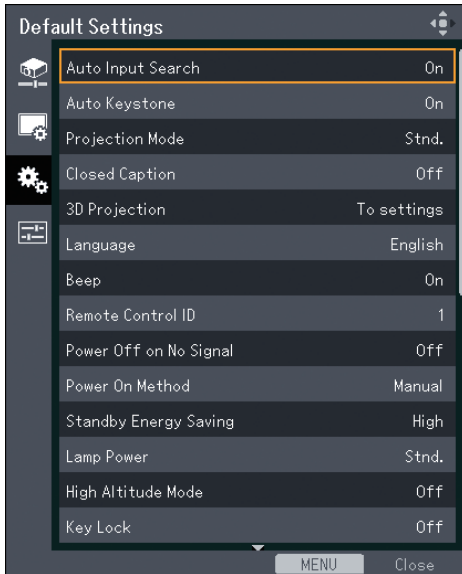

If [To settings] is displayed on the right, the item has a submenu. Press the [Enter] button to display the submenu screen.

5. Press the [Enter] button.

If [Execute] is displayed to the right of the item you select, the function is executed in this step.

6. Change the settings.

The method for changing the settings depends on the item.

- Adjusting values using the values bar

Change the value using the [◀] and [▶] buttons, and then press the [Enter] button.

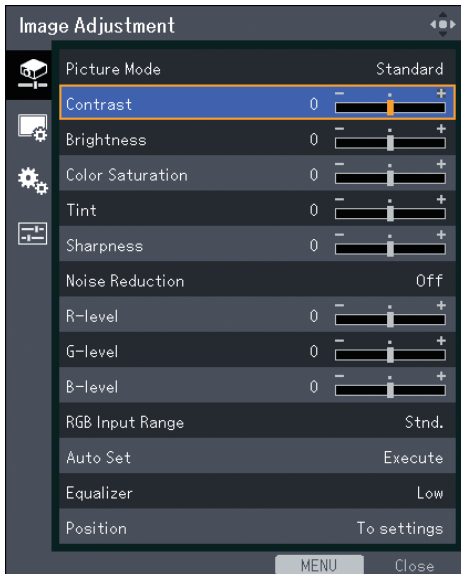

3

- Selecting the value from a list

Change the value using the [▲], [▼], [◀], and [▶] buttons, and then press the [Enter] button.

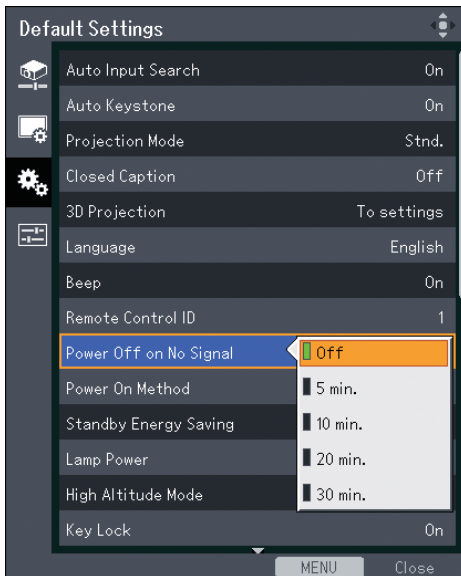

- Inputting numbers

Use the number buttons on the remote control to input numbers.

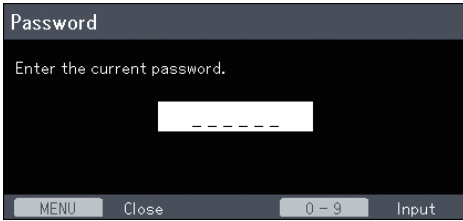

Note

- The control panel on the projector can be used for operations, but numbers for settings cannot be inputted.
- A confirmation screen appears before some functions are executed or some settings are changed.
- Changes to the settings are automatically applied when you close the menu screen. You do not need to press the [Enter] button.

Restoring Settings to Their Default Settings

This section explains the method for restoring the projector settings to the default values using the remote control.

1. Press the [Menu] button.

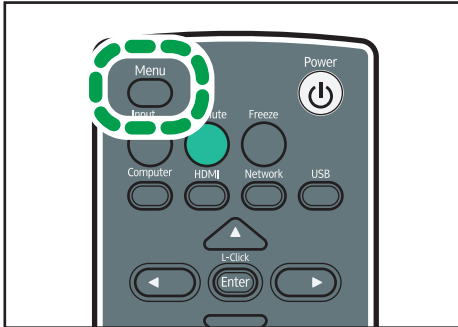

CLB046

2. Select the Default Settings menu tab, and then press the [▶] button.

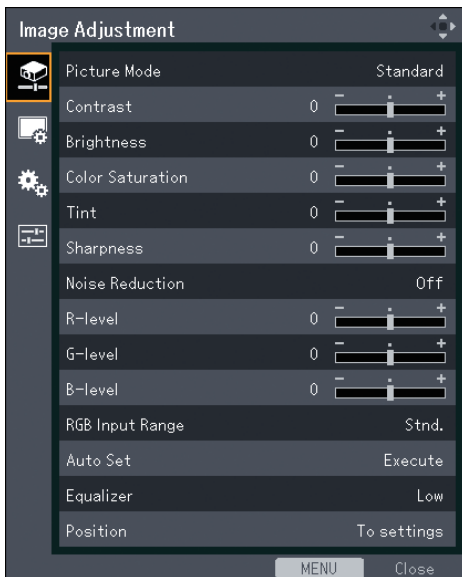

3. Select [Reset All], and then press the [Enter] button.

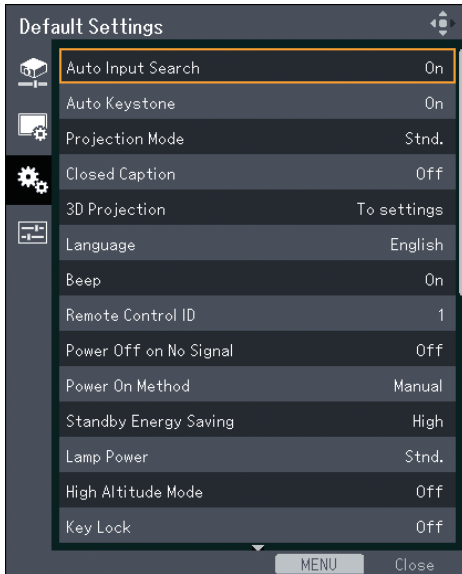

3

4. Select [OK] in the confirm screen, and then press the [Enter] button.

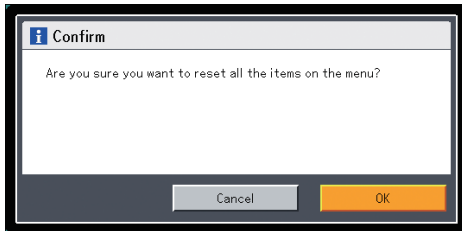

Note

- The following settings cannot be reset with this function:
 - [User Logo] in [Display Settings]
To reset the registered user logo, select [Reset Logo] in [Display Settings].
 - [Password] in [Default Settings]
To reset the registered passwords, contact your service representative.

List of Menu Items

Image Adjustment menu

Item	Summary
Picture Mode	Select the picture mode.
Contrast	Adjust the image contrast.
Brightness	Adjust the image brightness.
Color Saturation	Adjust the color saturation of the image.
Tint	Adjust the tint of the image.
Sharpness	Adjust the sharpness of the image.
Noise Reduction	Select whether or not to use the function to reduce the Y/Pb/Pr (480i/576i) or video signal noise.
R-level	Adjust the level of red in the image.
G-level	Adjust the level of green in the image.
B-level	Adjust the level of blue in the image.
RGB Input Range	Select the RGB input range.
Auto Set	Automatically adjust the items set for the image according to the type of input signal.
Equalizer	Select the strength of the functions that reduce the HDMI signal noise.
Position	Adjust the values for the image position.

Display Settings menu

Item	Summary
Keystone	Adjust for image keystone distortion.
Aspect	Select the screen size of the image.
Display Position	Move the image if the projected image is smaller or larger than the screen size.

Item	Summary
Wall Color Correction	Select the image hue according to the projection surface when the image is being projected on something other than a screen.
Background on NoSignal	Select the image display when there is no input signal.
Display Help	Select whether or not to display Help when there is no input signal.
Display Icon	Select whether or not to display icons when switching the input signals and settings.
Start-up Screen	Select whether or not to display the start-up screen when the projector is turned on.
User Logo	Register and confirm user logos.

Default Settings menu

Item	Summary
Auto Input Search	Select whether or not to only select inputs with signals when switching input signals.
Auto Keystone	Select whether or not to implement keystone correction automatically depending on the angle of the projector's position.
Projection Mode	Select the projection method according to how the projector is positioned.
Closed Caption	Select the closed caption display method.
3D Projection	Specify 3D projection.
Language	Select the language in which to display menus, etc.
Beep	Select whether or not to beep during use.
Remote Control ID	Select the projector remote control ID.
Power Off on No Signal	Select the time from the final operation to automatic power shutdown when there are no input signals.

Item	Summary
Power On Method	Select whether or not to use the auto power on function.
Standby Energy Saving	Select the level of energy saving while on standby.
Lamp Power	Select the lamp power level.
High Altitude Mode	Select whether or not to increase the speed of the fan.
Key Lock	Select whether or not to lock the buttons on the control panel.
Reset All	Reset all menus to their defaults.
Password	Register a password for the projector.

Display Status

Item	Summary
Input	Displays the selected input signals.
Resolution	Displays the resolution.
Frequency	Displays the synchronous frequency.
Sync	Displays the synchronous signal polarity.
Signal Format	Displays the Y/Pb/Pr signal format.
Video Mode	Displays the video signal color format.
Lamp Time	Displays the lamp usage time.
Lamp Reset Count	Displays the number of lamp replacements.
Total Time	Displays the projector usage time.
Total CO ₂ Reduction	Displays the total CO ₂ amount that can be reduced by setting the lamp mode to eco mode.
Eco Time Ratio	Displays the ratio of the time eco mode was used to the total use time.

Item	Summary
Main FW Version	Displays the version of the firmware on the main board.

Image Adjustment Menu

Picture Mode

Select the picture mode.

This function is not available when you select [On] in [3D Projection] under [Default Settings].

Default: **[Standard]**

- Bright

This image mode makes it easier to see the projection in bright locations.

- Standard

This is the standard image mode.

- Natural

Photos appear more natural in this mode.

Contrast

Adjust the image contrast.

The greater the value, the stronger the image contrast.

Default: **0**

- -16 to +16

Brightness

Adjust the image brightness.

The greater the value, the brighter the image.

Default: **0**

- -16 to +16

Color Saturation

Adjust the color saturation of the image.

The greater the value, the richer the image.

This function is available when you select [Y/Pb/Pr] or [Video] as an input signal.

Default: **0**

- -16 to +16

Tint

Adjust the tint of the image.

This function is available when you select [Y/Pb/Pr], [HDMI] (Y/Pb/Pr signals), or [Video] as an input signal.

Default: **0**

- -16 to +16

Sharpness

Adjust the sharpness of the image.

The greater the value, the sharper the image.

Default: **0**

- -8 to +8

Noise Reduction

Select whether or not to use the function to reduce the Y/Pb/Pr (480i/576i) or video signal noise.

This function is available when you select [Y/Pb/Pr] (480i/576i) or [Video] as an input signal.

Default: **[Off]**

- On
- Off

R-level

Adjust the level of red in the image.

The greater the value, the stronger the color red is in the image.

Default: **0**

- -16 to +16

G-level

Adjust the level of green in the image.

The greater the value, the stronger the color green is in the image.

Default: **0**

- -16 to +16

B-level

Adjust the level of blue in the image.

The greater the value, the stronger the color blue is in the image.

Default: **0**

- -16 to +16

RGB Input Range

Select the RGB input range.

When connecting an AV equipment which outputs a full-range RGB signal by HDMI cable, the image becomes clearer by selecting [Full].

This function is available when you select [HDMI] (RGB signals) as an input signal.

Default: **[Full]**

- Std.
- Full

Auto Set

Automatically adjust the items set for the image according to the type of input signal.

This function is available when you select [Computer] as an input signal.

Equalizer

Select the strength of the functions that reduce the HDMI signal noise.

This function is available when you select [HDMI] as an input signal.

Default: **[Low]**

- Low
- High

Position

Adjust the values for the image position.

This function is available when you select [Computer] as an input signal.

- Phase

Adjust to eliminate image flicker.

Default: **+16**

- 0 to +31

- Frequency

Adjust to eliminate moiré patterns and flicker when you project images with thin vertical-stripes.

Default: **0**

- -64 to +64

- H-position

Adjust the horizontal position of the image.

Default: **0**

- -64 to +64

- V-position

Adjust the vertical position of the image.

Default: **0**

- -32 to +32

- Clamp Pulse 1

Adjust the clamp pulse position.

- 0 to +255
- Clamp Pulse 2

Adjust the clamp pulse width.

- 0 to +255

Display Settings Menu

Keystone

Adjust for image keystone distortion.

This setting changes automatically depending on the angle of the projector position if you select [On] in [Auto Keystone] under [Default Settings].

Default: **0**

- -32 to +32

Aspect

Select the screen size of the image.

Default: **[Normal]**

- Normal
Display in full screen without changing the input signal aspect ratio.
- 16:9
Display using 16:9 aspect ratio (1280 × 720 resolution).
- Full
Display using 1280 × 800 resolution.
- Native
Display the image without changing the resolution of the input signal.
- Zoom
Display the image width as the projection screen width while maintaining the input signal aspect ratio.

Display Position

Move the image if the projected image is smaller or larger than the screen size.

You can move the image using the [▲], [▼], [◀], and [▶] buttons.

Wall Color Correction

Select the image hue according to the projection surface when the image is being projected on something other than a screen.

Default: **[Off]**

- Off
- Whiteboard
- Beige
- Gray
- Blackboard (Green)

Background on NoSignal

Select the image display when there is no input signal.

Default: **[Logo]**

- Logo
- Blue
- None

Display Help

Select whether or not to display Help when there is no input signal.

Default: **[On]**

- On
- Off

Display Icon

Select whether or not to display icons when switching the input signals and settings.

Default: **[On]**

- On
- Off

Start-up Screen

Select whether or not to display the start-up screen when the projector is turned on.

Default: **[On]**

- On
- Off

User Logo

Register and confirm user logos.

User logos can be displayed in the start-up screen or as the background when there are no input signals.

- Register Logo

Register a user logo. You can register an image with a resolution of up to 1280 × 800 pixels.

Project the image to be registered as a user logo, and then execute this function.

This function is available when you select [Computer], [HDMI] (RGB signals), or [Network] as an input signal.

- Confirm Logo

Display the registered user logo.

- Reset Logo

Delete the registered user logo.

Default Settings Menu

Auto Input Search

Select whether or not to only select inputs with signals when switching input signals.

Default: **[On]**

- On
- Off

Auto Keystone

Select whether or not to implement keystone correction automatically depending on the angle of the projector's position.

Default: **[On]**

- On
- Off

Projection Mode

Select the projection method according to how the projector is positioned.

Default: **[Std.]**

- Std.
Select this mode when the projector is placed in front of a screen.
- Rear
Select this mode when the projector is placed behind a screen.

Closed Caption

Select the closed caption display method.

The projector supports closed captioning, which allows subtitles to be displayed at the bottom of the picture. This is pursuant to the regulations set forth by the US Federal Communications Commission (FCC).

Select [CC-1] to [CC-4] to display the dialogue and narration of TV programs and videos that are closed captioned.

This function is available when you select [Video] as an input signal.

Default: **[Off]**

- Off
- CC-1
- CC-2
- CC-3
- CC-4

3D Projection

Specify 3D projection.

3D projection is compatible with the field sequential signal and the frame sequential signal.

- 3D Projection

Select whether or not to use 3D projection.

The image will be slightly darker if this is set to [On].

Default: **[Off]**

- On
- Off

- DLP Link

Select whether or not to synchronize 3D images and DLP images.

Default: **[On]**

- On
- Off

- L/R Reverse

Select whether or not to reverse left and right in a 3D image.

Default: **[Normal]**

- Normal
- Reverse

Language

Select the language in which to display menus, etc.

Default: **[English]**

Beep

Select whether or not to beep during use.

Default: **[On]**

- On
- Off

Remote Control ID

Select the projector remote control ID.

Specify the ID for each projector when operating multiple projectors using one remote control.

Default: **[1]**

- 1
- 2

- 3
- 4

Power Off on No Signal

Select the time from the final operation to automatic power shutdown when there are no input signals.

Default: **[Off]**

- Off
- 5 min.
- 10 min.
- 20 min.
- 30 min.

Power On Method

Select whether or not to use the auto power on function.

Default: **[Manual]**

- Manual
Turn the projector on when the [Power] button is pressed.
- Auto.
Automatically turn on the projector when the power cord is connected.

Standby Energy Saving

Select the level of energy savings while on standby.

You can save power by using this function. However, this function affects start-up time. Select a mode according to how you use the projector.

Default: **[High]**

- High
The energy saving level is high, but start-up time is slower.
- Low
The energy saving level is low, but start-up time is faster.

Lamp Power

Select the lamp power level.

Select [Eco] if the image is too bright or when projecting images in a dark room.

Default: **[Std.]**

- Eco
- Std.

High Altitude Mode

Select whether or not to increase the speed of the fan.

The number of fan rotations is high when set to [On]. Select [On] only when using the projector at an altitude of more than 1,500 meters (4,921 feet). Do not select [On] when the altitude is less than 1,500 meters (4,921 feet).

Default: **[Off]**

- On
- Off

Key Lock

Select whether or not to lock the buttons on the control panel.

You can change this setting to [Off] by pressing the [AV Mute] button on the projector's control panel for 10 seconds.

Default: **[Off]**

- On
- Off

Reset All

Reset all menus to their defaults.

This function cannot restore the default settings of [User Logo] in [Display Settings] and [Password] in [Default Settings].

Password

Register a password for the projector.

- Register Password

Enter a 6-digit password.

The current password is required to change the password.

Default: **[000000]**

- Password Protect

Select whether or not to enter a password when the projector is turned on. If this is selected, a password must be entered when the projector is turned on after the power cord has been unplugged. However, a password is not required when turning the projector on from the standby mode.

A password is required to change this setting.

Default: **[Off]**

- On
- Off

Display Status

Input

Displays the selected input signals.

Resolution

Displays the resolution.

This item appears when you select [Computer] or [HDMI] as an input signal.

Frequency

Displays the synchronous frequency.

This item appears when you select [Computer] or [HDMI] as an input signal.

Sync

Displays the synchronous signal polarity.

This item appears when you select [Computer] as an input signal.

Signal Format

Displays the Y/Pb/Pr signal format.

This item appears when you select [Y/Pb/Pr] as an input signal.

Video Mode

Displays the video signal color format.

This item appears when you select [Video] as an input signal.

Lamp Time

Displays the lamp usage time.

Lamp Reset Count

Displays the number of lamp replacements.

Total Time

Displays the projector usage time.

Total CO₂ Reduction

Displays the total CO₂ amount that can be reduced by setting the lamp mode to eco mode.

Eco Time Ratio

Displays the ratio of the time eco mode was used to the total use time.

Main FW Version

Displays the version of the firmware on the main board.

4. Troubleshooting

This chapter explains the basic problems and troubleshooting methods when an indicator light is lit.

Indicator Display List



The projector uses the [Power] button, indicators, and beeps to notify you if a malfunction occurs. Check the indicator's status, and implement the following measures.

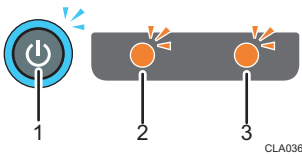

Indicator display image

The [Power] button is located on top of the projector. The indicators are on the front of the projector. For details, see p. 12 "Projector Parts and Their Functions".



1. [Power] button
2. Lamp indicator
3. Temp indicator

Status	Causes	Solutions
<p>The projector does not turn on.</p> 	<p>The projector is malfunctioning.</p>	<p>Disconnect the power cord, and contact your service representative.</p>
<p>"Hardware Error" was displayed, and the projector turned off during operation.</p> 	<p>The projector has an internal malfunction.</p>	<p>Disconnect the power cord, wait a while, and then turn on the projector again.</p> <p>If the problem cannot be resolved, contact your service representative.</p>

Status	Causes	Solutions
<p>The lamp turned off during operation, or it does not turn on</p> 	<ul style="list-style-type: none"> • The lamp has overheated and cannot turn on. • The lamp's service life has expired. • The projector has malfunctioned. 	<ul style="list-style-type: none"> • Disconnect the power cord, wait a while, and then turn on the projector again. • If the lamp burns out, replace it with a new lamp. For details of how to replace the lamp, see p.75 "Replacing the Lamp".
<p>The lamp does not turn off.</p>  <p>Flashing interval: 2 seconds</p>	<p>The projector has an internal malfunction.</p>	<p>Disconnect the power cord, wait a while, and then turn on the projector again.</p> <p>If the problem cannot be resolved, contact your service representative.</p>
<p>The projector turned off during operation, or it does not turn on.</p>  <p>Flashing interval: 1 second</p>	<p>The lamp cover is not installed correctly.</p>	<p>Disconnect the power cord, and reinstall the lamp cover correctly. For details of how to install the lamp cover, see p.75 "Replacing the Lamp".</p>
<p>"Temperature Error" was displayed, and the projector turned off during operation.</p> 	<ul style="list-style-type: none"> • The interior has overheated. • The projector is being used in a high-temperature environment. 	<p>Place the projector so that the intake and exhaust vents are not blocked.</p> <p>Disconnect the power cord, wait a while, and then turn on the projector again.</p>
<p>"Fan Error" was displayed, and the projector turned off during operation.</p> 	<p>The cooling fan in the projector has malfunctioned.</p>	<p>Disconnect the power cord, and contact your service representative.</p>

Status	Causes	Solutions
<p>"Installation Error" was displayed, and the projector turned off during operation, or it does not turn on.</p> 	<p>The projector's angle is too great.</p>	<p>Place the projector at a proper angle, and then turn it on again.</p>

Note

- "🔦" means the indicator is flashing.

Common Problems

If you think a malfunction has occurred, check the following before contacting your service representative.

Problem	Solutions
Power does not turn on.	<ul style="list-style-type: none"> • Make sure the power plug or connector is connected correctly. • Make sure the lamp cover is mounted correctly. For details, see p.75 "Replacing the Lamp".
Power turns off during use.	<ul style="list-style-type: none"> • Make sure the environment in which the projector is being used is within the acceptable temperature range. • Make sure the vents are not blocked.
No image.	<ul style="list-style-type: none"> • Make sure the input signal is switched correctly if [Auto Input Search] in [Default Settings] is set to [Off]. For details, see p.59 "Default Settings Menu". • Make sure the mute function is not turned on. See p.35 "Temporarily blanking the image and muting the audio". • Check the settings of [Brightness] in [Image Adjustment]. For details, see p.53 "Image Adjustment Menu". • Make sure the computer or AV equipment is connected to the projector correctly. For details, see p.23 "Connecting Equipment to the Projector". • Make sure the computer's image output is switched correctly. For details, see p.30 "When projecting the screen of a notebook computer". • Make sure the computer or AV equipment is working properly.

Problem	Solutions
No sound.	<ul style="list-style-type: none"> • Press the [Input] button. For details, see p.29 "Selecting an Input Signal". • Make sure the mute function is not turned on. For details, see p.35 "Temporarily blanking the image and muting the audio". • Check the speaker's volume adjustment. For details, see p.34 "Adjusting the Volume of the Speaker". • Make sure the computer or AV equipment is connected to the projector correctly. For details, see p.23 "Connecting Equipment to the Projector". • Make sure the computer or AV equipment is working properly.
Image is not projected normally.	<ul style="list-style-type: none"> • Make sure the input signal is compatible with the projector. For details, see p.81 "List of Compatible Signals". • Check the status of the video tape or other video source.
Image is blurred. Image is partially out of focus.	<ul style="list-style-type: none"> • Make sure the projection window is clean. For details, see p.74 "Cleaning the Projection Window". • Check the focus adjustment. For details, see p.32 "Adjusting the focus". • Make sure the projection distance is within the projector's range. For details, see p.21 "Relationship Between the Projection Distance and the Screen Size". • Check the installation angles of the projector and screen. For details, see p.30 "Adjusting the Angle of the Projection". • Check the settings of [Sharpness] and [Phase] in [Image Adjustment]. For details, see p.53 "Image Adjustment Menu".

Problem	Solutions
Image is dark.	<ul style="list-style-type: none"> • Check the settings of [Brightness] and [Contrast] in [Image Adjustment]. For details, see p.53 "Image Adjustment Menu". • Make sure the lamp is not near the end of its service life. For details, see p.63 "Display Status". • Check the settings of [RGB Input Range] in [Image Adjustment]. For details, see p.53 "Image Adjustment Menu". • Make sure [3D Projection] in [Default Settings] is set to [Off]. For details, see p.59 "Default Settings Menu".
Color is faded. Tint is poor.	<ul style="list-style-type: none"> • Check the settings of [Color Saturation], [R-level], [G-level], and [B-level] in [Image Adjustment]. For details, see p.53 "Image Adjustment Menu". • Make sure the screen is clean. • Check the settings of [Wall Color Correction] in [Display Settings]. For details, see p.57 "Display Settings Menu". • Make sure the lamp is not near the end of its service life. For details, see p.63 "Display Status"
The projector's operation keys do not respond.	<ul style="list-style-type: none"> • Make sure [Key Lock] in [Default Settings] is not set to [On]. For details, see p.59 "Default Settings Menu".

Problem	Solutions
The remote control does not respond.	<ul style="list-style-type: none"> • Make sure the ID assigned to the remote control and in the settings of [Remote Control ID] in [Default Settings] are the same. For details, see p.59 "Default Settings Menu". • Make sure the batteries in the remote control are not dead. • Make sure the batteries are correctly loaded into the remote control. For details, see p.18 "Loading Batteries into the Remote Control". • Make sure the remote control is inside its effective range. For details, see p.17 "Effective Range of the Remote Control". • Make sure there is nothing placed between the remote control and the projector. • Make sure the remote control receiver is not exposed to strong light.
Display language is unknown.	<ul style="list-style-type: none"> • Press the [Menu] button, and then select the display language in [XXX/Language] (XXX differs from the current display language) under  tab. For details, see p.59 "Default Settings Menu".

Knowledge Base

If you have any questions about the projector, refer to the knowledge base. Visit our global Web site listed below, and then access a knowledge base page in your language.

<http://www.ricoh.com/support/>

You can search the knowledge base by product name or keyword.

5. Maintenance

This chapter explains the operating precautions and maintenance for the projector.

Operating Precautions

Pay attention to the following points when using the projector:

- If moving the projector under conditions including vibration and shock, use both the packing case and included carrying bag. Transporting the projector using the carrying bag only may damage it due to shock or vibration. Further, transporting the projector in a damaged packing case may damage the projector, so use a packing case that is in good condition.
- Do not apply volatile substances such as insecticide to the projector. Also, do not bring the projector into long-term contact with rubber or vinyl products. Doing so may cause discoloration or the paint to peel.
- The projector is not intended for long-term continuous operation. Further, remove the projector from the packing case before using. If a malfunction occurs when using the projector under these conditions, a fee is charged for repair even if the warranty is still in effect.
- Do not use locations that may be hot, such as near a heater. Doing so may cause the projector to malfunction or reduce the service life.
- Avoid locations that may become smoky. Particulates may adhere to the optical parts, reducing the service life and causing the image to darken.
- Using the projector close to a television or radio may adversely affect the images and sound. If this happens, move the projector away from the television or radio.
- Moving the projector from a low-temperature location to a high-temperature location may cause water droplets to form on the projector lens and parts due to condensation. Continued use under such conditions may cause malfunction, so do not use the projector until the water droplets have evaporated.
- The air is thin at high elevations, so the cooling efficiency of the projector is reduced. Select [On] in [High Altitude Mode] before using.
- Do not use the projector in an extremely inclined position ($\pm 20^\circ$ or greater). Doing so may cause malfunction or reduce the service life.
- Do not use benzene or paint thinners. Doing so may cause the projector to warp, discolor, or the paint to peel. Further, do not use cleaning cloths that contain chemicals.

Cleaning the Projector

WARNING

- Do not remove any covers or screws that are not mentioned in this manual. There are high voltage components inside the product that may cause electric shock. Contact your service representative if any of the product's internal components require maintenance, adjustment, or repair.
- Do not disassemble or modify the product. Doing so may cause injury or malfunction.

CAUTION

- When performing maintenance on the machine, always disconnect the power cord from the wall outlet.

5

Cleaning the Projection Window

When cleaning the projection window, make sure to do the following:

- Use a commercially available blower or cloth for cleaning glass, cleaning paper, lens cleaner, etc.
- The projection window surface scratches easily, so do not rub or tap it with a hard object.

Cleaning the Projector

When cleaning the projector, make sure to do the following:

- Disconnect the power plug before cleaning.
- Gently wipe any dirt from the projector using a soft cloth. Using a damp cloth may cause water to seep inside the projector and cause electric shock or malfunction.
- Do not use benzene or paint thinners. Doing so may cause the projector to warp, discolor, or the paint to peel. Further, do not use cleaning cloths that contain chemicals.

Replacing the Lamp

WARNING

- Before replacing the lamp, turn off the power and wait at least one hour to allow the product to cool completely. If it is not completely cool, you may burn or injure yourself due to the inside of the product and lamp unit being hot. If you replace the lamp without unplugging the power cord from the power outlet, electric shock or explosion may occur.
- Be careful when handling the used lamp so that it does not break. If it breaks, it may cause injury.

CAUTION

- Be sure to always use a dedicated replacement lamp that is new when replacing the lamp. If you use a lamp that is not dedicated, it may result in an explosion and injury.

Important

- **The lamp is a glass product. Do not touch the glass surface with bare hands, hit it forcefully, or damage it.**
- **This projector's lamp contains trace amounts of environmentally harmful inorganic mercury. Be careful not to break used lamps, and dispose of them in accordance with local regulations or contact your sales representative or service representative.**

When the lamp is due for replacement, the message "The lamp is reaching the end of its life. Please change it." is displayed. Change the lamp as instructed.

Furthermore, if the lamp is used for an extended period of time, the image may darken or the lamp may burn out. If this happens, replace the lamp with a new one.

When [Lamp Power] in [Default Settings] is specified as [Standard], replace the lamp after approximately 3,000 hours. When the setting is [Eco], replace it after approximately 4,000 hours. This may differ, however, depending on how the lamp is used.

1. **Turn over the projector and place it on a flat surface so that you can see the bottom of the projector.**

2. Turn the knob counterclockwise, and then open the lamp cover.

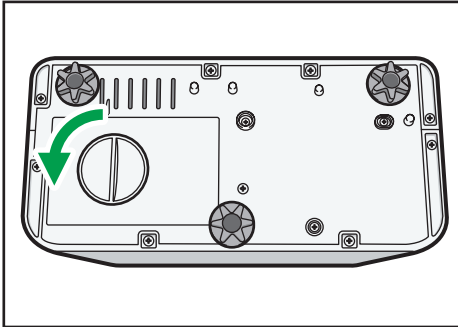

CLB059

3. Raise the metal handle.

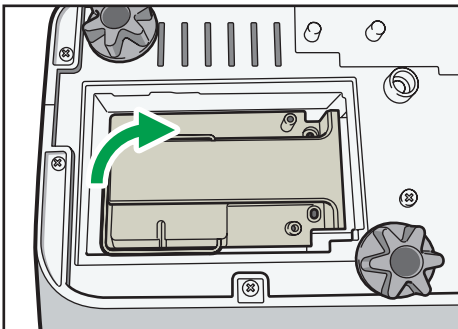

CLB061

4. Hold the handle, and then pull the lamp unit out of the projector.

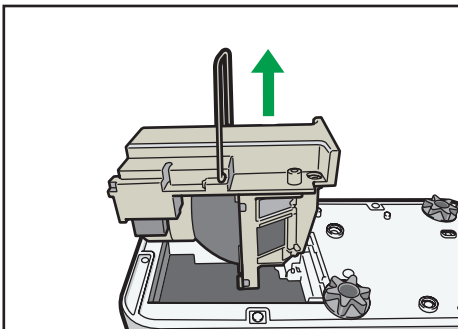

CLB062

5. Insert a new lamp unit.

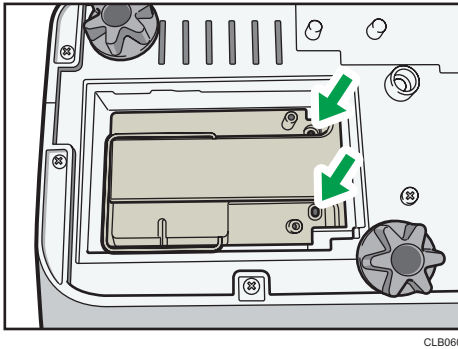

Make sure that the small projections inside the projector are inserted into the holes of the lamp unit properly.

6. Close the lamp cover.

Correctly install the outer lamp cover. Incorrect installation may prevent the lamp or projector from turning on.

7. Reset the lamp time.

For the reset method, see the manual provided with the lamp.

↓ Note

- The lamp's service life can be verified using [Lamp Time] in [Display Status].
- The lamp may stop working before it reaches its approximate service life or before the replacement message is displayed.

Consumables

- Lamp unit
Replacement Lamp Type 3

Note

- Contact your sales or service representative for information about consumables.

6. Appendix

This chapter explains the projector's specifications and compatible signals. This chapter also explains where to inquire about the projector and related services.

Specifications

Specifications for the Projector

Component	Specifications
Power consumption	291 W or less
Weight	Approx. 3.0 kg (6.7 lb.)
External dimensions (not including protruding parts)	257 × 144 × 221 mm (10.1 × 5.7 × 8.7 inches)
Operating environment	Temperature: 5 to 35°C (73 to 95°F), Humidity: 30 to 70%
Display element	<ul style="list-style-type: none">• Display method Single-chip DLP®• Panel size 0.65 inches• Pixels 1,024,000 pixels (1280 H × 800 V)
Projection method	Ultra short-focus lens/mirror projection method
Lamp	High-pressure mercury lamp (Standard mode: 225 W, Eco mode: 170 W)
Projection screen size	48 to 80 inches
Projection distance	12 to 25 cm (4.6 to 9.8 inches)
Speaker	2 W (Mono)

Component	Specifications
Connection ports	<ul style="list-style-type: none"> • COMPUTER In port Mini D-SUB15 × 1 • HDMI port (HDCP compliant)* HDMI × 1 • Video In port RCA_1 pin × 1 • Audio In port Mini Jack × 1 • Control port USB-TYPE-minB × 1

* HDCP (High-bandwidth Digital Content Protection) is a copyright protection method to encrypt digital signals across the DVI/HDMI interface and prevent unauthorized copying. The HDCP specification was developed and is licensed by Digital Content Protection, LLC. The HDMI port on this projector is HDCP compliant and can project digital video content protected by HDCP. Updates to the HDCP specification may void this compliance and prevent access to protected data. If this occurs, it is not caused by the projector.

List of Compatible Signals

Set the computer and AV equipment output signals so that they match the input signals compatible with the projector.

If resolutions or signal frequencies that are not compatible with the projector are input, the image may flicker or become blurred. Further, the image may not be displayed.

↓ Note

- Images with a resolution greater than 1280 × 800 are compressed when displayed, so some of the information may be lost or the image may deteriorate.

Computer Input

Mode	Resolution		Frequency		
	Horizontal (pixel)	Vertical (pixel)	Vertical (Hz)	Horizontal (kHz)	Clock (MHz)
640 × 480	640	480	59.940	31.469	25.175
			72.809	37.861	31.500
			75.000	37.500	31.500
			85.008	43.269	36.000
720 × 400	720	400	85.039	37.927	35.500
800 × 600	800	600	56.250	35.156	36.000
			60.317	37.879	40.000
			72.188	48.077	50.000
			75.000	46.875	49.500
			85.061	53.673	56.250
832 × 624	832	624	74.550	49.725	57.283
848 × 480	848	480	60.000	31.020	33.750

Mode	Resolution		Frequency		
	Horizontal (pixel)	Vertical (pixel)	Vertical (Hz)	Horizontal (kHz)	Clock (MHz)
1024 × 768	1024	768	60.004	48.363	65.000
			70.069	56.476	75.000
			75.029	60.023	78.750
			84.997	68.678	94.500
			74.700	60.134	79.857
1152 × 864	1152	864	75.000	67.500	108.000
1152 × 870	1152	870	75.062	68.682	100.001
1280 × 720	1280	720	60.000	45.000	74.250
1280 × 768	1280	768	59.995	47.396	68.250
			59.870	47.776	79.500
			74.893	60.289	102.250
			84.837	68.633	117.500
1280 × 800	1280	800	59.910	49.306	71.000
			59.810	49.702	83.500
			74.934	62.795	106.500
			84.880	71.554	122.500
1280 × 960	1280	960	60.000	60.000	108.000
			75.019	75.019	126.032
			85.002	85.937	148.500
1280 × 1024	1280	1024	60.020	63.981	108.000
			75.025	79.976	135.000
			85.024	91.146	157.500
1360 × 768	1360	768	60.015	47.712	85.500

Mode	Resolution		Frequency		
	Horizontal (pixel)	Vertical (pixel)	Vertical (Hz)	Horizontal (kHz)	Clock (MHz)
1366 × 768	1366	768	60.000	48.000	72.000
			59.790	47.712	85.500
1400 × 1050	1400	1050	59.948	64.744	101.000
			59.978	65.317	121.750
			74.867	82.278	156.000
1440 × 900	1440	900	59.901	55.469	88.750
			59.887	55.935	106.500
			74.984	70.635	136.750
			84.842	80.430	157.000
1600 × 900	1600	900	60.000	60.000	108.000
1600 × 1200	1600	1200	60.000	75.000	162.000
1680 × 1050	1680	1050	59.883	64.674	119.000
			59.954	65.290	146.250

Y/Pb/Pr Input

Mode	Resolution		Frequency		
	Horizontal (pixel)	Vertical (pixel)	Vertical (Hz)	Horizontal (kHz)	Clock (MHz)
480i (525i)	720	242.5	59.940	15.734	13.500
480p (525p)	720	483	59.940	31.469	27.000
576i (625i)	720	288	50.000	15.625	13.500
576p (625p)	720	576	50.000	31.250	27.000
720 / 50p	1280	720	50.000	37.500	74.250

Mode	Resolution		Frequency		
	Horizontal (pixel)	Vertical (pixel)	Vertical (Hz)	Horizontal (kHz)	Clock (MHz)
720 / 60p	1280	720	60.000	45.000	74.250
1080 / 50i	1920	540	50.000	28.125	74.250
1080 / 60i	1920	540	60.000	33.750	74.250
1080 / 50p	1920	1080	50.000	56.250	148.500
1080 / 60p	1920	1080	60.000	67.500	148.500

Video Input

Mode	Frequency
	Vertical (Hz)
NTSC	59.940
PAL	50.000
SECAM	50.000
PAL-M	59.940
PAL-N	50.000
PAL60	59.940
NTSC4.43	59.940

HDMI Input

Mode	Resolution		Frequency		
	Horizontal (pixel)	Vertical (pixel)	Vertical (Hz)	Horizontal (kHz)	Clock (MHz)
480i (525i)	720	242.5	59.940	15.734	13.500
576i (625i)	720	288	50.000	15.625	13.500

Mode	Resolution		Frequency		
	Horizontal (pixel)	Vertical (pixel)	Vertical (Hz)	Horizontal (kHz)	Clock (MHz)
480p (525p)	720	483	59.940	31.469	27.000
576p (625p)	720	576	50.000	31.250	27.000
720 / 50p	1280	720	50.000	37.500	74.250
720 / 60p	1280	720	60.000	45.000	74.250
1080 / 50i	1920	540	50.000	28.125	74.250
1080 / 60i	1920	540	60.000	33.750	74.250
1080 / 24p	1920	1080	24.000	27.000	74.250
1080 / 30p	1920	1080	30.000	33.750	74.250
1080 / 50p	1920	1080	50.000	56.250	148.500
1080 / 60p	1920	1080	60.000	67.500	148.500
640 × 480	640	480	59.940	31.469	25.175
			72.809	37.861	31.500
			75.000	37.500	31.500
			85.008	43.269	36.000
720 × 400	720	400	85.039	37.927	35.500
800 × 600	800	600	56.250	35.156	36.000
			60.317	37.879	40.000
			72.188	48.077	50.000
			75.000	46.875	49.500
			85.061	53.673	56.250
832 × 624	832	624	74.550	49.725	57.283
848 × 480	848	480	60.000	31.020	33.750

Mode	Resolution		Frequency		
	Horizontal (pixel)	Vertical (pixel)	Vertical (Hz)	Horizontal (kHz)	Clock (MHz)
1024 × 768	1024	768	60.004	48.363	65.000
			70.069	56.476	75.000
			75.029	60.023	78.750
			84.997	68.678	94.500
			74.700	60.134	79.857
1152 × 864	1152	864	75.000	67.500	108.000
1152 × 870	1152	870	75.062	68.682	100.001
1280 × 720	1280	720	60.000	45.000	74.250
1280 × 768	1280	768	59.995	47.396	68.250
			59.870	47.776	79.500
			74.893	60.289	102.250
			84.837	68.633	117.500
1280 × 800	1280	800	59.910	49.306	71.000
			59.810	49.702	83.500
			74.934	62.795	106.500
			84.880	71.554	122.500
1280 × 960	1280	960	60.000	60.000	108.000
			75.019	75.019	126.032
			85.002	85.937	148.500
1280 × 1024	1280	1024	60.020	63.981	108.000
			75.025	79.976	135.000
			85.024	91.146	157.500
1360 × 768	1360	768	60.015	47.712	85.500

Mode	Resolution		Frequency		
	Horizontal (pixel)	Vertical (pixel)	Vertical (Hz)	Horizontal (kHz)	Clock (MHz)
1366 × 768	1366	768	60.000	48.000	72.000
			59.790	47.712	85.500
1400 × 1050	1400	1050	59.948	64.744	101.000
			59.978	65.317	121.750
			74.867	82.278	156.000
1440 × 900	1440	900	59.901	55.469	88.750
			59.887	55.935	106.500
			74.984	70.635	136.750
			84.842	80.430	157.000
1600 × 900	1600	900	60.000	60.000	108.000
			60.000	75.000	162.000
1680 × 1050	1680	1050	59.883	64.674	119.000
			59.954	65.290	146.250

Specifications for Ports

Computer In Port

Pin assignment

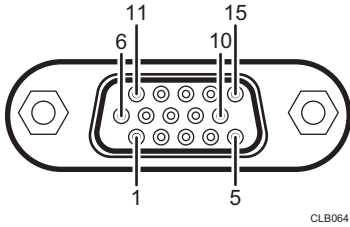

Pin No.	Pin description	
	During RGB input	During Y/Pb/Pr input
1	Video signal (R)	Color difference signal (Pr)
2	Video signal (G)	Luminance signal (Y)
3	Video signal (B)	Color difference signal (Pb)
4	N.C	-
5	GND	-
6	GND (R)	GND (Pr)
7	GND (G)	GND (Y)
8	GND (B)	GND (Pb)
9	N.C	-
10	GND	-
11	N.C	-
12	I ² C Data	-
13	Horizontal sync signal	-
14	Vertical sync signal	-
15	I ² C CLOCK	-

Input Signal

- RGB input
RGB signals: 0.7V (p-p), 75 Ω
Horizontal sync signal: TTL level (Pos/neg polarity)
Vertical sync signal: TTL level (Pos/neg polarity)
- Y/Pb/Pr input
Y signal: 1.0V (p-p), 75 Ω
Pb/Pr signals: 0.7V (p-p), 75 Ω

Control Port

Interface format

Communication method	RS-232C, 115,200bps, No Parity, Data Length: 8 bits; Stop Bit Length: 1 bit
Communication format	#(23h)' + Command + CR (0Dh) Only 1 command valid per communication. For the available commands, see "Main commands".
Data format	For input commands, only ASCII-compliant all-uppercase alphanumeric characters supported.
Replies	<ul style="list-style-type: none"> • Acknowledge (Aborted) '=(3Dh)' + Command(3byte) + ':(3Ah)' + 'E(45h)' + 'R(52h)' + 'O(30h)' + CR(0Dh) • No acknowledge '=(3Dh)' + 'E(45h)' + 'R(52h)' + 'O(30h)' + CR(0Dh) For details of Acknowledge (Normally ended), see "Main commands".

Main commands

Item	Command	Acknowledge (Normally ended) *
Power on	PON	=PON:SC0
Power off	POF	=POF:SC0

Item	Command	Acknowledge (Normally ended) *
Icon display on	ICN:1	=ICN:1
Icon display off	ICN:0	=ICN:0
Auto setting (RGB input)	PAT	=PAT:SC0
Status display on	DON	=DON:SC0
Status display off	DOF	=DOF:SC0
RGB input	INP:1	=INP:1
Y/Pb/Pr input	INP:2	=INP:2
HDMI input	INP:5	=INP:5
Video input	INP:9	=INP:9

* CR is added to the end of "Acknowledge (Normally ended)".

Note

- The control port is for service representatives or administrators of the projector.
- A USB driver must be installed to control the projector using the control port. For details, contact your service representative.

Where to Inquire

Contact your sales or service representative for further information about topics covered in this manual or to inquire about topics not covered in this manual.

Trademarks

Adobe, Acrobat, and Reader are either registered trademarks or trademarks of Adobe Systems Incorporated in the United States and/or other countries.

DLP is a registered trademark of Texas Instruments. DLP Link is a trademark of Texas Instruments.

HDMI and High-Definition Multimedia Interface are trademarks or registered trademarks of HDMI Licensing, LLC.

Microsoft[®], PowerPoint[®], Windows[®], and Windows Vista[®] are either registered trademarks or trademarks of Microsoft Corporation in the United States and/or other countries.

VGA and WXGA are trademarks or registered trademarks of IBM Corporation in the United States, other countries or both.

Other product names used herein are for identification purposes only and might be trademarks of their respective companies. We disclaim any and all rights to those marks.

The proper names of the Windows operating systems are as follows:

- The product names of Windows XP are as follows:

Microsoft[®] Windows[®] XP Professional Edition

Microsoft[®] Windows[®] XP Home Edition

Microsoft[®] Windows[®] XP Media Center Edition

Microsoft[®] Windows[®] XP Tablet PC Edition

Microsoft[®] Windows[®] XP Professional x64 Edition

- The product names of Windows Vista are as follows:

Microsoft[®] Windows Vista[®] Ultimate

Microsoft[®] Windows Vista[®] Business

Microsoft[®] Windows Vista[®] Home Premium

Microsoft[®] Windows Vista[®] Home Basic

Microsoft[®] Windows Vista[®] Enterprise

- The product names of Windows 7 are as follows:

Microsoft[®] Windows[®] 7 Home Premium

Microsoft[®] Windows[®] 7 Professional

Microsoft[®] Windows[®] 7 Ultimate

Microsoft[®] Windows[®] 7 Enterprise

INDEX

3D Projection.....60

A

AC In socket.....14
Accessories.....10
Adjustable feet.....13, 30
Adjusting for keystone distortion.....33
Adjusting the focus.....32
Adjusting the image.....31, 33
Adjusting the projection angle.....30
Adjusting the volume.....34
Angle of the projection.....30
Arrow buttons.....12, 15
Aspect.....57
Aspect button.....15, 37
Audio In port.....14
Auto Input Search.....59
Auto Keystone.....59
Auto Set.....55
Auto set button.....15, 33
AV Mute button.....12, 15, 35

B

B-level.....54
Background on NoSignal.....58
Basic operations.....27
Beep.....60
Blanking the image.....35
Brightness.....53

C

Changing the aspect ratio.....37
Changing the image quality.....37
Changing the settings.....43
Changing the size of the image.....31
Cleaning.....74
Clear button.....15
Closed Caption.....59
Color Saturation.....53
Common problems.....68
Compatible signals.....81
Compatible signals (Computer input).....81

Compatible signals (HDMI input).....84
Compatible signals (Video input).....84
Compatible signals (Y/Pb/Pr input).....83
Computer button.....15
Computer In port.....14, 88
Connecting a computer.....23
Connecting AV equipment.....24
Connecting equipment.....23
Connecting the power cord.....25
Consumables.....78
Contrast.....53
Control panel.....12
Control port.....89
Copyrights to Images.....4

D

Default Settings menu.....59
Display Help.....58
Display Icon.....58
Display Position.....57
Display Settings menu.....57
Display Status.....63

E

Eco button.....15, 38
Eco Time Ratio.....63
Effective range.....17
Enlarging the image.....35
Enter button.....12, 15
Equalizer.....55
Error.....65
Exhaust vents.....13

F

Fan Error.....65
Focus.....32
Focus lever.....13, 32
Freeze button.....15, 36
Frequency.....63
Front view.....13

G

G-level.....54
Guide button.....15

H

Hardware Error.....	65
HDMI button.....	15
HDMI port.....	14
High Altitude Mode.....	62
How to read this manual.....	8

I

ID button.....	15
Image Adjustment menu.....	53
Important.....	4
Indicator display list.....	65
Indicators.....	13
Input.....	63
Input button.....	12, 15, 29
Input signal.....	29
Inquiry.....	91
Installation Error.....	65
Intake vents.....	14
Introduction.....	4

K

Key Lock.....	62
Keystone.....	57
Keystone button.....	15, 33
Knowledge Base.....	71

L

Lamp.....	75
Lamp power.....	38
Lamp Power.....	61
Lamp Reset Count.....	63
Lamp Time.....	63
Language.....	28, 60
Left-side view.....	13
Loading batteries.....	18

M

Magnify button.....	15, 35
Main functions.....	9
Main FW Version.....	63
Manipulating images.....	34
Manuals.....	6, 7
Menu button.....	12, 15

Menu items.....	49
Menu screen.....	41, 43, 47
Muting the audio.....	35

N

Network button.....	15
Noise Reduction.....	54
Notebook computer.....	30
Notes.....	8
Number buttons.....	15

O

Operating Instructions.....	6
Operating precautions.....	73

P

Page button.....	15
Password.....	62
Pausing the image.....	36
PDF manual.....	7
Picture button.....	15, 37
Picture Mode.....	53
Position.....	55
Positioning the projector.....	21
Power button.....	12, 15, 28, 38
Power cord.....	25
Power Off on No Signal.....	61
Power On Method.....	61
Precautions.....	73
Projecting an image.....	27
Projecting the computer's screen.....	30
Projection distance.....	21
Projection height.....	21
Projection Mode.....	59
Projection window.....	12, 74
Projector parts.....	12

R

R-Click button.....	15
R-level.....	54
Rear view.....	14
Remote control.....	15, 17, 18, 34
Remote Control ID.....	19, 60
Remote control receiver.....	13

Replacing the lamp.....	75
Reset All.....	47, 62
Resolution.....	63
Restoring the settings.....	47
RGB Input Range.....	54
Right-side view.....	14

S

Safety Information.....	6
Screen size.....	21
Security slot.....	14
Selecting an input signal.....	29
Setup Guide.....	6
Sharpness.....	54
Signal Format.....	63
Speaker.....	13
Specifications for ports.....	88
Specifications for the projector.....	79
Standby Energy Saving.....	61
Start menu.....	28
Start-up Screen.....	58
Switching the lamp mode.....	38
Symbols.....	8
Sync.....	63

T

Temperature Error.....	65
Tint.....	53
Top view.....	12
Total CO2 Reduction.....	63
Total Time.....	63
Trademarks.....	92
Troubleshooting.....	65, 68
Turning off the projector.....	38
Turning on the projector.....	28

U

USB button.....	15
User Logo.....	58

V

Video In port.....	14
Video Mode.....	63
Volume button.....	15, 34

W

Wall Color Correction.....	57
Where to inquire.....	91

Z

Zoom button.....	15, 31
------------------	--------

MEMO

